

FEB. 7th  
1931

# RADIO

REG. U.S. PAT. OFF.

# WORLD

The First and Only National Radio Weekly  
463d Consecutive Issue—NINTH YEAR

Price  
**15 Cents**  
Per Copy

SHORT-WAVE  
CONVERTER  
TROUBLE-  
SHOOTING

MATCHING  
SPEAKER  
AND  
OUTPUT TUBE

## HERE'S HOW TO GET EUROPE!



Using two 227 tubes, a short-wave converter has been developed, to work with any set, and provide high sensitivity. The battery model uses two 230 tubes. See article on pages 5, 6 and 7.

# BRACH RELAY

**ONLY 99c**

List price, \$4.50

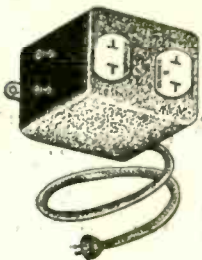

Connect relay's cable plug to 105-125 volt AC line. Connect B eliminator cable plug to relay socket so marked; connect trickle or other charger's plug to relay socket so marked; connect one side of A battery to binding post, other side to A set. Then turning on your set turns on B eliminator and turns off charger, turning off set turns on charger and turns off B eliminator.

GUARANTY RADIO GOODS CO.  
143 West 45th Street  
New York City—Just E. of B'way

# Hammarlund SFL



Hammarlund's precision .0005 mfd. condenser, removable shaft; excellent for calibrated radio frequency oscillators, short-wave converters and adapters and TRF or Superheterodyne broadcast receivers. Lowest loss construction; rigidity; Hammarlund's perfection throughout.

Order Cat. HAM-SFL. List price \$5.50; net price.....\$3.00

GUARANTY RADIO GOODS CO.  
143 West 45th St., New York, N. Y.



## Your Choice of NINE Meters!

To do your radio work properly you need meters. Here is your opportunity to get them at no extra cost. See the list of nine meters below. Heretofore we have offered the choice of any one of these meters free with an 8-weeks subscription for RADIO WORLD, at \$1, the regular price for such subscription. Now we extend this offer. For the first time you are permitted to obtain any one or more or all of these meters free, by sending in \$1 for 8-weeks' subscription, entitling you to one meter; \$2 for 16 weeks, entitling you to two meters; \$3 for 26 weeks, entitling you to three meters; \$4 for 35 weeks, entitling you to four meters; \$5 for 44 weeks, entitling you to five meters; \$6 for 52 weeks, entitling you to six meters. Return this offer with remittance, and check off desired meters in squares below.

RADIO WORLD, 145 West 45th Street, New York, N. Y. (Just East of Broadway)

Enclosed please find \$.....for.....weeks subscription for RADIO WORLD and please send as free premium the meters checked off below.

I am a subscriber. Extend my subscription. (Check off if true.)

- 0-8 Voltmeter D.C. .... No. 326
- 0-50 Voltmeter D.C. .... No. 337
- 8-Volt Charge Tester D.C. .... No. 23
- 0-10 Amperes D.C. .... No. 338
- 0-25 Milliamperes D.C. .... No. 325
- 0-50 Milliamperes D.C. .... No. 350
- 0-100 Milliamperes D.C. .... No. 390
- 0-300 Milliamperes D.C. .... No. 399
- 0-400 Milliamperes D.C. .... No. 394

NAME .....

ADDRESS .....

CITY..... STATE.....

# The New Jiffy Tester

## Chromium-Plated Case and Accurate Meters

A NEW and improved Jiffy Tester, improved in both performance and appearance, is Model JT-N. The meters are of the moving iron type. Tested on precise batteries, they show errors not exceeding 2%. As for appearance, the case is first copper plated, then nickel plated, then chromium plated, giving a lustrous, permanent, non-peeling non-rusting finish. It is the same finish found on hardware in fine automobiles. The handle and lock strap are genuine leather.

Jiffy Tester, Model JT-N, consists of three double-reading meters, with cable plug, 4-prong adapter, test cords and screen grid cable, enabling simultaneous reading of plate voltage, plate current and filament or heater voltage (DC or AC), when plugged into the socket of any set. The ranges are filament, heater or other AC or DC: 0-10 v, 0-140 v; plate current: 0-20, 0-100 ma; plate voltage: 0-60, 0-300 v. It makes all tests former models made. Each meter is also independently accessible for each range. The entire device is built in a chromium-plated case with chromium-plated slip-cover. Instruction sheet will be found inside. Order Cat. JT-N.

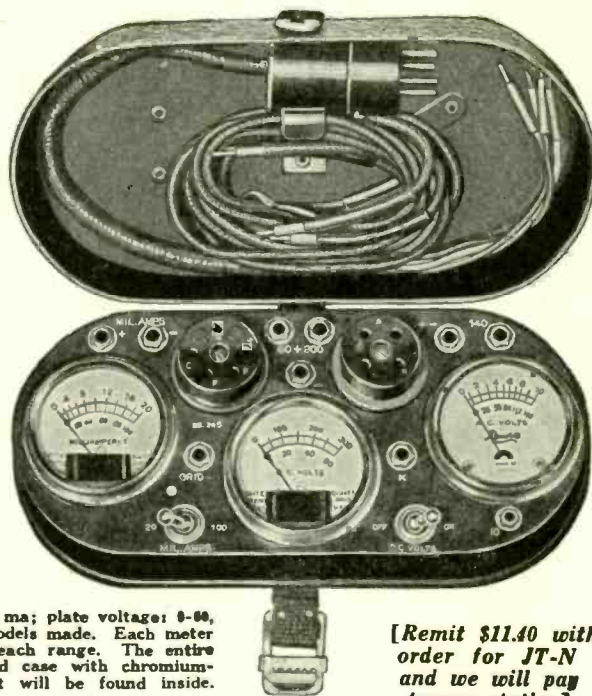

[Remit \$11.40 with order for JT-N and we will pay transportation]

GUARANTY RADIO GOODS CO.  
143 WEST 45th STREET (Just East of Broadway) NEW YORK, N. Y.

The inductor dynamic offers high sensitivity and true tonal response. It requires no exciting field current, unlike other dynamics. Order model R for 112 or 112A, and Model G for all other output tubes.

- Cat. 9-G (9" extreme outside diameter) \$8.48
- Cat. 9-R .....\$8.49
- Cat. 12-G (12" extreme outside diameter) .....\$10.03
- Cat. 12-R .....\$10.03

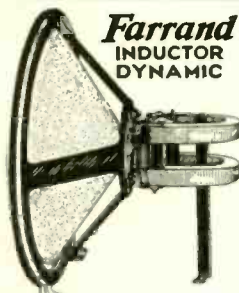

Farrand  
INDUCTOR  
DYNAMIC

GUARANTY RADIO GOODS CO.  
143 W. 45th St., New York, N. Y.

FIDELITY HORN UNIT—Stands up to 450 volts without filtering. Can be used in the portable without horn attached. Price, \$2.25. Guaranty Radio Goods Co., 143 W. 45th St., New York.

## RADIO WORLD and "RADIO NEWS"

BOTH FOR ONE YEAR @ \$7.00

You can obtain the two leading radio technical magazines that cater to experimenters, service men and students, the first and only national radio weekly and the leading monthly, for one year each, at a saving of \$1.50. The regular mail subscription rate for Radio World for one year, a new and fascinating copy each week for 52 weeks, is \$6.00. Send in \$1.00 extra, get "Radio News" also for a year—a new issue each month for twelve months. Total, 64 issues for \$7.00.

If renewing Radio World subscription, put cross in square.  
RADIO WORLD, 145 West 45th Street, New York, N. Y.

FIDELITY HORN UNIT—Stands up to 450 volts without filtering. Can be used in the portable without horn attached. Price, \$2.75. Guaranty Radio Goods Co., 143 W. 45th St., New York.

## Three 0.1 mfd. in One Case

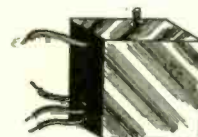

Cat. SUP-31

Three Supertone non-inductive fixed condensers of 0.1 mfd. each, (250 v.) in steel case, provided with a 6/32 mounting screw, built in. The black lead is common to the three condensers, the three red leads are the other sides of the respective capacities. Size, 1 1/2" square by 1/2" wide. Order Cat. SUP-31, list price, \$1.00; net price, 57c.

GUARANTY RADIO GOODS CO.  
143 West 45th St., New York, N. Y.

## Horn Unit \$1.95



Fidelity Unit, Cat., FDU.

The Fidelity unit is pre-eminent for horn type speakers such as exponential horns. The faintest word from a "whispering tenor" or the tumultuous shout of the crowd or highest crescendo of the band is brought out clearly, distinctly. Stands up to 450 volts without filtering.

Works right out of your set's power tube, or tubes requiring no extra voltage source. Standard size nozzle and thread. Works great from AC set, battery set or any other set, push-pull or otherwise. The casing is full nickel finish, highest polish. This unit can be used in a portable without any horn attached and will give loud reproduction. Order Cat. FDU, with 50-inch tipped cord; weight, 3/4 lb.; size, 2 1/2-inch diameter, 2 1/2-inch height. (This is the large size) Price.....\$1.95

GUARANTY RADIO GOODS CO.  
143 West 45th Street, New York City

## "A" BATTERY SWITCH



A push-pull switch for battery-operated sets. Made by Benjamin Firm, sure contact, extremely long life. Special price, only.....\$1.35

GUARANTY RADIO GOODS CO.  
143 West 45th St., New York, N. Y.

**BUY NOW**  
While Prices Are Lowest!

Now all the fans who build their own sets or service men who are making replacements are using the dry electrolytic condenser. It affords high lasting capacity in compact form. The lug at top represents the anode and goes to the positive side (B+ or C+), while the aluminum case is to go to the negative side, usually ground. The capacity of the condenser is 8 mfd. The condenser, a product of Aerovox, is admirably suited for use in filter circuits, for use on rectified AC or pulsating DC. The condenser must not be used on raw AC. Maximum peak voltage, 500 volts DC. Normal operating voltage, 400 volts DC. Dry, self-healing, high capacity, low leakage, unaffected by moisture. Size, 1-5/16" diam. x 4 1/2" overall. Mounts in any position. Brackets supplied. Order Cat. AV-8 @ \$1.42

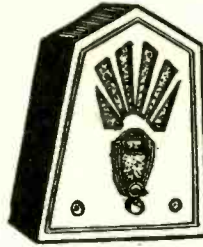
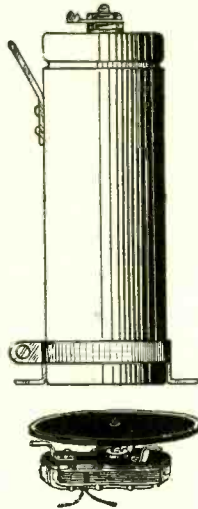

An outstanding example of the vastly popular midget receiver, not very much larger than any good speaker, yet it contains a very sensitive, efficient and powerful AC radio set, AC power pack and a speaker that would do justice reproducing the output of the most elaborate AC receiver! Startling statements, yes, but they are undeniable facts! Imagine, not even as large as most battery operated portable sets, and lighter in weight! The set will duplicate in performance (considering selectivity, sensitivity and volume) that of its much larger and more costly brothers! One dial tuning control, also switch and volume control knob (not illustrated.) Uses six tubes: three 224, one 227, one 245 and one 280. Perfect reproduction! Combined weight of entire set, speaker and tubes less than 20 lbs.! Entirely self-contained! 5 gang tuning condenser. Uses power tubes and push-pull electro-dynamic speaker! Durably built in handsome walnut case. For 110-120 volts, 50-60 cycle AC. Complete set, with the six tubes, cabinet, speaker—nothing else to buy! Order Cat. MDST @ \$39.95

**Peerless Dynamic In Sonora Console**

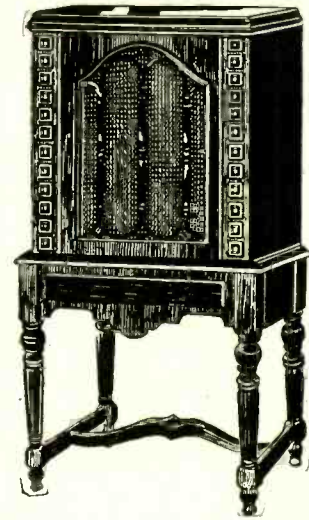

Positively the last word in the most efficient and powerful reproducer made! As a fitting companion, it is housed in a truly exquisite deep two-tone walnut console, of rare beauty and craftsmanship! To properly handle the ultra-powerful Peerless chassis, a chamber 15" deep, 17 1/2" wide and 18" high houses same. Front baffle of 3/4" thickness! Size of opening, 10 inches. Ideal for use with the most powerful public address amplifier. NO RATTING, NO DISTORTION—JUST PERFECT REPRODUCTION! For that matter it is equally suited with ordinary sets, employing the average type of audio amplification systems. Order Cat. SSC @ \$24.99 [If cabinet only is desired (less speaker) order Cat. SCO @ \$13.44]

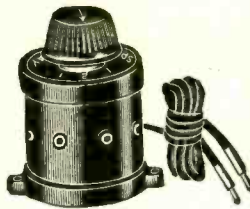

New Speaker-relay for connecting two speakers to it and playing either one (position No. 1, left); or the other (position No. 2, right); or both at once (position No. 2); by turning the knob. Built into an attractive black moulded bakelite case, with 18-inch connecting cords to go to the output posts of the receiver or amplifier. The speakers' cords are connected to the relay by plugging into built-in jacks. This device can be used also for switching from "phonograph pickup" to "radio." Order Cat. 121 @ \$1.10

Synchronous motor for 60-cycle lines, 105 to 125 volts, with turntable, producing 80 turntable revolutions per minute. Takes up to 21-inch records. Sturdy and compact, this motor is only 1 1/4 inches thick. Not affected by line voltage fluctuations. The compactness permits installation in consoles or any other available space. Made by Allen-Hough, makers of the Phono-link pickup. Shipping weight, 7 lbs. Order Cat. SYN-M (with turntable) @ \$4.25

**PHONOGRAPH PICK-UP \$3.32**

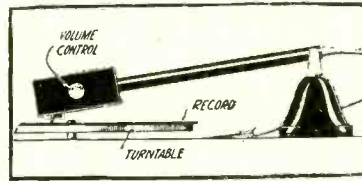

The famous Phono-link, made by Allen-Hough, enables playing phonograph records electrically, on your set. Volume control is built in. Adapter, free with each order, enables immediate connection to your set. Instruction sheet enclosed. Order Cat. PHL @ \$3.32.

**0-600 Voltmeter Reads Both AC and DC**

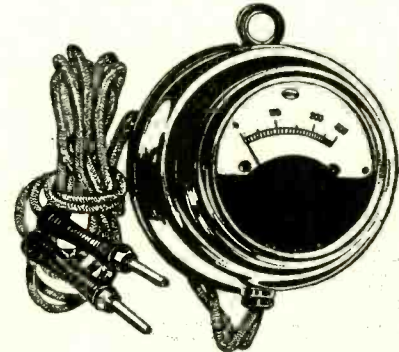

0-600 volts, high resistance; AC and DC (same meter reads both types). DC readings accurate to 2%, also AC readings 2% at 50-60 cycles, but accuracy is less on AC at substantially different frequencies. Order Cat. F-600 @ \$4.95  
0-300 volts, high resistance. Accuracy, 3%. Case is full nickel finish. Long connecting cords have especially ornamental tip holders. Meter should be read in perpendicular position. Order Cat. F-300 @ \$2.50  
0-500 volts, same as above in appearance, but the range is greater. Order Cat. F-500 @ \$3.73

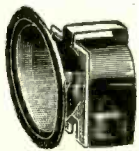

Here is the best buy of the year: A 15" diameter, 110 volt D.C. dynamic chassis, with two field coil resistances, 800 ohms AND 4,000 ohms. Contains push-pull output transformer. Designed for use with any super-power amplifier—for audioterm reproduction. Shipping weight, 25 lbs. Order Cat. 1100 @ \$18.95



Natural bakelite tubing, made by Spaulding, in two diameters, 1 1/2 inches and 2 inches, outside diameters. One will fit inside the other even after wire is wound on the smaller diameter. Length Diam. Price 1 1/2" 1 1/2" \$0.09 2" 2" .12 36" 2" .40 The 1 1/2" length, 1 1/2" diameter, can be used for winding a primary, and be inserted.

**Temple Dynamic \$15.34 Beautiful Carved Wood Grille Front**

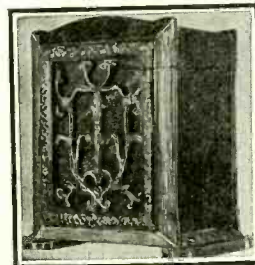

This is one of the finest dynamic speakers ever made, and is highly recommended by us. AC switch is provided. A knob is built in for adjusting the speaker impedance to that of your set. An output transformer and dry rectifier are built in. Connect plugged AC cable to 110 volts AC, 50 to 60 cycles and connect tipped cords to speaker post of receiver. This remarkable speaker The Temple 10 chassis in the fascinatingly decorative walnut cabinet, with carved grille ornament, as illustrated; both front and back finished. (Cabinet not sold separately.) Order Cat. TEM @ \$15.34

We also offer the following Peerless dynamic chassis:

Cat.	Size	Type	Price
719	14"	110 v. D.C.	\$14.95
720	12"	110 v. A.C.	15.95
721	12"	110 v. D.C.	8.95
1020	12"	6 v. D.C.	8.95
1021	10"	110 v. A.C.	11.95
1022	9"	110 v. A.C.	8.95
1023	9"	110 v. D.C.	7.95
1034	9"	6 v. D.C.	7.95

**EXTRA-SPECIAL SPECIALS!**

- (Cat. SPEC-1)—Eria DC dynamic chassis, 9-inch cone, for operation from 6-volt storage battery. Connect speaker-tipped cords to output of set, and connect twisted pair to 6-volt storage battery. Draw 1/2 amp. from battery. Price.....\$9.00
- (Cat. SPEC-2)—Wave trap, for cutting out interference. Connect aerial to one side of the trap, other side to antenna post of receiver from which aerial was removed, and tune out interfering stations. A great selectivity booster. Price.....\$7
- (Cat. SPEC-3)—Rider's Supplement No. 1, containing diagrams supplemental to those in Rider's "Trouble Shooting Manual," and an invaluable addition, for completeness, to any who possess Rider's manual. Price.....1.22
- (Cat. SPEC-4)—Dubiller .01 mfd. fixed mica condenser......16
- (Cat. SPEC-5)—Dubiller .00025 mfd. mica fixed condenser, with clips for grid leak mounting......11
- (Cat. SPEC-6)—.0001 mfd. Dubiller fixed condenser, for connection in series with aerial to improve selectivity......11
- (Cat. SPEC-7)—Power transformer, with two chokes built in for B filtration. Primary, 105-125 volts, 50-60 cycles; secondaries, all center-tapped with red leads, are for high voltage for 280 to work 245 tubes, single or push-pull, and rest of tubes in set up to 100 mba; 300 volts DC output; 2 1/2 volts 2 amps. for 245s, single or push-pull; 2 1/2 volts 14 amps. for 227s and 245s, up to 2 of these; 5 volts for filament of 280. All, including chokes, in one cadmium plated steel case. Leads identified. Chokes are 30 henries each..... 7.50

**Special "Buy-Now" Bargain Coupon!**

GUARANTY RADIO GOODS CO., 143 West 45th Street, New York, N. Y. (Just East of Broadway)

- Please ship at once the following:
- |  |  |  |
|--|--|--|
| <input type="checkbox"/> Cat. AV-8 @ \$1.42  | <input type="checkbox"/> Cat. SCO @ \$13.44  | <input type="checkbox"/> Cat. 1021 @ \$11.95 |
| <input type="checkbox"/> Cat. MDST @ \$39.95 | <input type="checkbox"/> Cat. 1100 @ \$18.95 | <input type="checkbox"/> Cat. 1022 @ \$9.95  |
| <input type="checkbox"/> Cat. 121 @ \$1.10   | <input type="checkbox"/> Cat. 719 @ \$14.95  | <input type="checkbox"/> Cat. 1023 @ \$7.95  |
| <input type="checkbox"/> Cat. SYN-M @ \$4.25 | <input type="checkbox"/> Cat. 720 @ \$15.95  | <input type="checkbox"/> Cat. 1024 @ \$7.95  |
| <input type="checkbox"/> Cat. PHL @ \$3.32   | <input type="checkbox"/> Cat. 721 @ \$8.95   | <input type="checkbox"/> Cat. TEM @ \$15.34  |
| <input type="checkbox"/> Cat. SSC @ \$24.99  | <input type="checkbox"/> Cat. 1020 @ \$9.95  |  |

**METERS**

- |  |  |  |
|--|--|--|
| <input type="checkbox"/> Cat. F-600 @ \$4.95 | <input type="checkbox"/> Cat. F-300 @ \$2.50 | <input type="checkbox"/> Cat. F-500 @ \$3.73 |
|--|--|--|
- EXTRA-SPECIAL SPECIALS!**
- |   |   |   |
|---|---|---|
| <input type="checkbox"/> Cat. SPEC-1 @ \$9.00 | <input type="checkbox"/> Cat. SPEC-3 @ \$1.22 | <input type="checkbox"/> Cat. SPEC-7 @ \$6.11 |
| <input type="checkbox"/> Cat. SPEC-2 @ \$7.50 | <input type="checkbox"/> Cat. SPEC-5 @ \$1.16 | <input type="checkbox"/> Cat. SPEC-8 @ \$7.50 |
| <input type="checkbox"/> Cat. SPEC-4 @ \$1.22 | <input type="checkbox"/> Cat. SPEC-6 @ \$1.11 |   |

Name.....  
Address.....  
City.....State.....  
(Above prices are on basis of remittance with order, but if C. O. D. is desired, if you enclose 1/4 of total amount, shipment will be made C.O.D. for balance.)

### A WIDE CHOICE OF PARTS

#### UNSHIELDED BROADCAST COILS ON 3" DIAMETER BAKELITE

- (Cat. SGT-5)—Three circuit tuned, for .0005 mfd. condenser, for use where the untuned high impedance primary is in the plate circuit of a screen grid tube. The tuned secondary may be connected to any type tube.....\$ .90
- (Cat. SGT-3)—Same as above, only for .00035 mfd. condenser.....\$ .90
- (Cat. 5-HT)—Special three-circuit tuner for .0005 mfd. tuned primary in plate circuit of a screen grid tube; untuned secondary.....\$ .95
- (Cat. 3-HT)—Same as Cat. 5-HT, except that it is for .00035 mfd. tuning.....\$ .95
- (Cat. T-5)—Standard 3-circuit tuner for .0005 mfd., where primary is for any type of tube other than plate circuit of screen grid tube.....\$ .80
- (Cat. T-3)—Same as T-5, except for .00035 mfd. condenser instead of for .0005.....\$ .80
- (Cat. 2-R5)—Radio frequency transformer for .0005 mfd. condenser where high impedance untuned primary is in plate circuit of a screen grid tube, and secondary is tuned.....\$ .60
- (Cat. 2-R3)—Same as 2-R5, except that it is for .00035 mfd. tuning.....\$ .60
- (Cat. 5-TP)—Radio frequency transformer for use where primary is tuned and placed in plate circuit of screen grid tube, while secondary is not tuned. For .0005 mfd.....\$ .55
- (Cat. 3-TP)—Same as Cat. 5-TP, except that it is for .00035 mfd. tuning.....\$ .55
- (Cat. RF-5)—Radio frequency transformer for .0005 mfd. tuning, where untuned primary is in plate circuit of any type tube except screen grid. Useful also as antenna coupler.....\$ .55
- (Cat. RF-3)—Same as Cat. RF-5, except that it is for .00035 mfd. tuning.....\$ .55

#### RADIO FREQUENCY CHOKES

- (Cat. 50-MLH)—A radio frequency choke coil for filtration in broadcast use, as in screen or plate leads, particularly detector plate, or in the output (plate circuit) of a short-wave converter. Mounting bracket supplied. Not shielded.....\$ .47
- (Cat. QML)—A radio frequency choke for short-wave work only. Inductance, 1/2 millihenry. Wound on 3/4" diameter bakelite rod, with connecting lugs at end, and mounting bracket.....\$ .47

#### FILTER AND BY-PASS CONDENSERS

- (Cat. HV-1)—Compact 1 mfd. filter condenser, for use in filter section of any B supply intended to work 245 tubes, single or push-pull, and rest of tubes in receiver.....\$ 1.50
- (Cat. HV-2)—Compact 2 mfd. condenser for 245 B supply.....\$ 2.50
- (Cat. AVX-8)—Compact 8 mfd. Aerovox dry electrolytic condenser with mounting bracket, for 245 B supply.....\$ 1.47
- (Cat. LV-1)—1 mfd. low-voltage condenser for bypassing 200 v. DC rating.....\$ .50
- (Cat. LV-2)—2 mfd. low-voltage condenser for bypassing 200 v. DC rating.....\$ 1.00
- (Cat. LV-4)—4 mfd. low-voltage condenser for bypassing 200 v. DC rating.....\$ 2.00
- (Cat. SUP-31)—Three 0.1 mfd. bypass condensers in one compact case. 200 v. DC rating.....\$ .57

#### KNOBBS AND DIALS

- (Cat. KNB-2)—2-inch diameter moulded bakelite black knob, no pointer; 1/4" shaft.....\$ .18
- (Cat. KNB-15)—1 1/2" diameter moulded bakelite black knob, no pointer; 1/4" shaft.....\$ .18
- (Cat. KNW-15)—1 1/2" diameter moulded bakelite walnut knob, with pointer; 1/4" shaft.....\$ .18
- (Cat. MCD)—Marco vernier dial; moulded bakelite; black; pilot light window.....\$ .60
- (Cat. NAT-H)—National velvet vernier drum dial, type H, with modernistic escutcheon, color wheel (rainbow feature).....\$ 3.13
- (Cat. NAT-G)—National velvet vernier flat type dial, for use when tuning condenser shaft is at right angles to the front panel; modernistic dial; single color protection.....\$ 2.05
- (Cat. NAT-VBD)—National velvet vernier black moulded bakelite circular dial, variable ratio lever, 6-1 to 20-1; reads 0-100-0; with dial light and bracket.....\$ 1.70

#### BLUEPRINTS

- (Cat. BP-3A)—Blueprint of three-tube Supertone short-wave converter, using 227 tubes; filament transformer external; coil winding data, list of parts, schematic diagram included.....\$ .25
- (Cat. BP-DLC)—Blueprint of DeLuxe short-wave converter, using two National VBD dials, two Hammarlund SFL .0005, precision plug-in coils.....\$ .25
- (Cat. BP-33)—Blueprint of the HB-33, seven-tube screen-grid battery set, using 122s for RF, push-pull 171A output.....\$ .25
- (Cat. BP-44)—Blueprint of the HB-44, eight-tube AC screen-grid set, 245 push-pull output; screen-grid power detector.....\$ .25
- (Cat. BP-SGD-4)—Blueprint of 4-tube battery Diamond of the Air, one stage BF 222, regenerative detector, two transformer audio.....\$ .25
- (Cat. BP-PPBD)—Blueprint of 5-tube battery Diamond. Extra tube due to push-pull output, either 112A or 171A.....\$ .25
- (Cat. BP-DBX)—Blueprint of 4-tube Diamond, for AC operation, screen-grid RF; no B supply, as 180-volt B eliminator is to be used.....\$ .25
- (Cat. BP-UNB)—Blueprint of 4-tube Universal, with 222 RF; battery operation.....\$ .25

#### GUARANTY RADIO GOODS CO.

143 West 45th Street, New York, N. Y.  
Enclosed please find \$..... for which please ship at once the following:

- |                                       |   |
|---------------------------------------|---|
| <input type="checkbox"/> SGT-5 @ 90c  | <input type="checkbox"/> LV-4 @ 2.00      |
| <input type="checkbox"/> SGT-3 @ 90c  | <input type="checkbox"/> SUP-31 @ 57c     |
| <input type="checkbox"/> 5-HT @ 95c   | <input type="checkbox"/> KNR-2 @ 18c      |
| <input type="checkbox"/> 3-HT @ 95c   | <input type="checkbox"/> KNB-15 @ 16c     |
| <input type="checkbox"/> T-5 @ 80c    | <input type="checkbox"/> KNW-15 @ 18c     |
| <input type="checkbox"/> T-3 @ 80c    | <input type="checkbox"/> MCD @ 60c        |
| <input type="checkbox"/> 2-R5 @ 60c   | <input type="checkbox"/> NAT-H @ 3.13     |
| <input type="checkbox"/> 2-R3 @ 80c   | <input type="checkbox"/> NAT-G @ 2.05     |
| <input type="checkbox"/> 5-TP @ 55c   | <input type="checkbox"/> NAT-VBD @ 1.70   |
| <input type="checkbox"/> 3-TP @ 55c   | <input type="checkbox"/> BP-3A @ 25c      |
| <input type="checkbox"/> RF-5 @ 55c   | <input type="checkbox"/> BP-DLC @ 25c     |
| <input type="checkbox"/> RF-3 @ 55c   | <input type="checkbox"/> BP-33 @ 25c      |
| <input type="checkbox"/> 50-MLH @ 47c | <input type="checkbox"/> BP-44 @ 25c      |
| <input type="checkbox"/> QML @ 47c    | <input type="checkbox"/> BP-SGD4 @ 25c    |
| <input type="checkbox"/> HV-1 @ 1.50  | <input type="checkbox"/> BP-PPBD @ 25c    |
| <input type="checkbox"/> HV-2 @ 2.50  | <input type="checkbox"/> BP-DBX @ 25c     |
| <input type="checkbox"/> AVX-8 @ 1.50 | <input type="checkbox"/> BP-UNB @ 25c     |
| <input type="checkbox"/> LV-1 @ 50c   |   |
| <input type="checkbox"/> LV-2 @ 1.00  | <input type="checkbox"/> Mail Items C O D |

Name.....  
Address.....  
City..... State.....

# POLO

## Short-Wave Converters Power Equipment

### RC-27 Converter

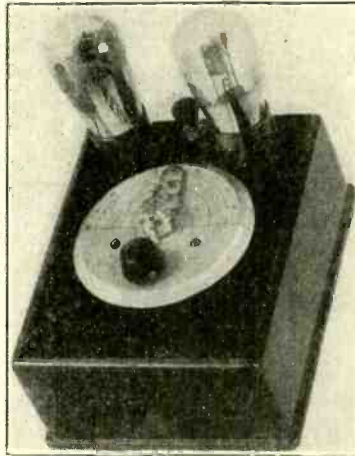

EXTREMELY high sensitivity is achieved in the very latest short-wave converter, Cat. RC-27, using two 227 tubes and one tuned circuit, with the new Hammarlund Junior midline condenser, covering 20-135 meters without plug-in coils. A coil switch changes the wave band. Used with any fairly good receiver, this AC Model converter penetrates uncanny distance, as users report direct reception of European and South American transmitters.

A 20-to-1 reduction ratio REL vernier dial makes accurate tuning easy, while call letters or frequencies may be written directly on the dial.

This latest sensation among short-wave fans has a Polo short-wave filament transformer built in. A positive B voltage, 50 volts or more, is to be obtained from your set.

The converter works with any broadcast receiver—Superheterodyne or tuned radio frequency—and without body capacity. Tuning is simple, no skill being required.

All parts, exactly as specified by Herman Bernard (less tubes), order Cat. RC-27 @ \$10.00

Wired model (less tubes), order Cat. RC-27-W @ \$12.00

### RC-30 CONVERTER

The battery model uses two 230 tubes, and gives the same performance as the AC model. For use with a 3-volt source of filament voltage, order Cat. RC-30-3 (all parts, less tubes), @ \$7.75

Wired Model, Cat. RC-30-3W @ \$9.75

For use with 6-volt battery, order Cat. RC-30-6 (all parts, less tubes), @ \$7.75

World Model, Cat. RC-30-6W, @ \$9.75

### INDIVIDUAL PARTS

- Hammarlund Junior .0002 mfd. midline condenser; turns in 2-inch diameter; extends only 2 1/2" back from panel; end stops built in, also tension adjuster. Order Cat. H-20, @ \$1.35
- REL vernier dial, order Cat. D, @ 85¢
- Wound coil for RC-27 and RC-30, order Cat. RCL, @ 60¢
- Short-wave filament transformer, Cat. SW-FLT, @ \$2.50

### The 1-A Unit

THE de luxe model all-wave converter tunes from 15 to 600 meters, using two tuned circuits, with a Hammarlund condenser in each. This model, the 1-A Unit, consists of a beautifully finished bakelite front panel and sub-panel, with National modernistic dial. A total of five plug-in coils is used.



Three screen grid tubes are used. Filament transformer is built-in, while AC switch is on the front panel.

The assembly is totally rigid and self-supporting, requiring no cabinet. This model is of the very finest type, and gives you the advantage of triple screen grid in a deluxe assembly.

All parts, including filament transformer and coils, but not tubes, order Cat. 1-A, @ \$19.87

Wired model, Cat. 1-AW, @ \$22.87

### Power Equipment POWER TRANSFORMER

THE 245 power transformer is for use with a 280 rectifier tube, to deliver 300 volts DC or 100 milliamperes, from 110 v., 50 - 60 cycles. The primary is tapped at 82 1/2 volts in case a voltage regulator (Clarostat or Amperite) is used. The black primary lead is common. If no voltage regulator is used the other primary lead is the green one. If regulator is used, the red and black form the circuit. The winding for heater type tubes stands 16 amperes.

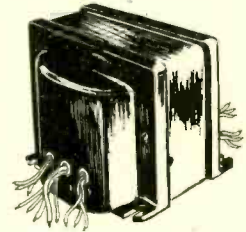

Shipping weight, 12 lbs. Overall size: 5" extreme width x 4 1/2" high. Order Cat. 245-PT @ \$9.50

### B SUPPLY CHOKE

100 ma choke coil for B filtration in 245 circuits; 200 ohms DC resistance, inductance 30 henrys. A continuous winding tapped in two places, giving three sections and four out-leads, and permitting a "choke input" to filter. By this method rectifier tube life and filter condenser life are lengthened yet filtration is splendid. The black lead goes to the rectifier filament center, the red, green and yellow leads are next in order. Capacities suggested: black, none; red, 1 mfd.; green, 8 mfd.; yellow, 8 mfd. In shielded, polished aluminum case. Shipping weight, 4 lbs. Order Cat. 245-CH @ \$4.00

### SHORT-WAVE FILAMENT TRANSFORMER

We manufacture the shielded filament transformer specified by Herman Bernard for the Short-Wave Converters. The primary is 110 v., 50-60 cycles; secondary, 2 1/2 volts, 8 amperes. No center tap is necessary. Order Cat. SW-FLT @ \$2.50

For 40 cycles, Cat. SW-FLT-40 @ \$3.20

For 220 v., 50-60 cycles, SW-FIT-220 @ \$3.00

## POLO ENGINEERING LABORATORIES

125 WEST 45TH STREET

NEW YORK, N. Y.

Our Entire Line on Exhibition at Our Office



Vol. XVIII. No. 21 Whole No. 463  
 February 7th, 1931  
 [Entered as second-class matter, March, 1922, at the Post Office at New York, N. Y., under act of March, 1879]  
 15c per Copy, \$6.00 per Year

**NINTH YEAR**  
 Technical Accuracy Second to None  
 Latest Circuits and News

A Weekly Paper published by Hennessy Radio Publications Corporation, from Publication Office, 145 West 45th Street, New York, N. Y. (Just East of Broadway)  
 Telephone, BRyant 9-0558 and 9-0559

RADIO WORLD, owned and published by Hennessy Radio Publications Corporation, 145 West 45th Street, New York, N. Y. Roland Burke Hennessy, president and treasurer, 145 West 45th Street, New York, N. Y.; M. B. Hennessy, vice-president, 145 West 45th Street, New York, N. Y.; Herman Bernard, Secretary, 145 West 45th Street, New York, N. Y.; Roland Burke Hennessy, editor; Herman Bernard, business manager and managing editor; J. E. Anderson, technical editor

# The High Road to Converter Sensitivity

By Herman Bernard

**T**HREE models of the two tube short-wave converter diagrammed in Fig. 1 were built up and submitted to as many radio fans, not technicians in any sense, and two of them reported the reception of European stations while the other complained he could not reach any farther than San Francisco from New York City.

One of the striking points about the converter, despite the use of only a pair of tubes, is that the sensitivity is extremely high. With a Neutrodyne broadcast receiver, using three stages of 227 radio frequency amplification, leaky-condenser 227 rectification, and two stages of transformer-coupled audio, the sensitivity of the combination of which these two devices were constituted, while varying with frequency, averaged less than 1 microvolt per meter.

As soon as you hear tell of such high sensitivity you naturally feel like exclaiming: "Great!" But there is another side to it.

## The Noise Level

Whenever the sensitivity is too great, as it well may be on some short-wave frequencies in particular, you simply get down below the noise level. Then the noise may be greater in amplitude than the signal. This noise is caused by static of various types and by amplification of noises developed in the system, such as tube noises.

This is nothing serious, or all you need do, when the noise is too great, is to turn down the volume control of the receiver with which the converter is operated, or use as aerial only twenty feet or so of wire under the carpet or around the molding.

Tested by the author, the two-tube converter brought in, at New York City, two Chicago stations on their short wave relays, WENR and WCFL, using only 4½ feet of aerial, which was the distance between the console on which the converter rested and the floor.

The asset of such great sensitivity results from a combination of precautions.

## How Sensitivity Arises

The utter omission of any and all radio frequency chokes will be noted. The coupler in the antenna circuit is a resistor of .02 meg. (20,000 ohms), while the load on the plate circuit of the modulator (upper tube in diagram) is also such a resistor. By that method all trapping effects due to large distributed capacity as might be present in a high-inductance radio frequency choke coils is avoided, and not only is response obtained all over the dial, but high sensitivity as well. Chokes of small inductance also could prevent dead spots, but would not afford as much sensitivity.

Due to the use of resistance coupling, the model therefore is called RC, there being the AC design, RC-27, as in Fig. 1, and the battery companion, RC-30, which works just as well, diagrammed in Fig. 4.

Even the grid leak is a small value of resistor, compared with values used for broadcast frequencies, while the grid condenser is a Hammarlund equalizer, 20-1000 mmfd., set at full capacity. This combination of grid condenser capacity and leak resistance

(Continued on following page)

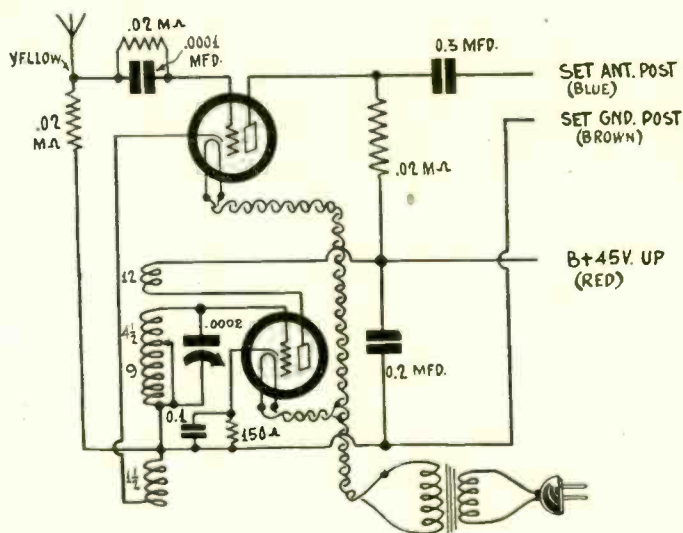

Fig. 1

Resistance coupling in antenna and output circuits marks the RC-27 short-wave converter, which covers 20-135 meters without plug-in coils.

## List of Parts

### Coils

- One oscillator coil as described.
- One Polo short-wave filament transformer with 6 ft. AC cable and plug separate.

### Condensers

- One Hammarlund special junior midline short-wave tuning condenser, .0002 mfd.
- One Hammarlund 20-100 mmfd. equalizer for use as grid condenser.
- Two condenser blocks, three condensers of 0.1 mfd. in each case.

### Resistors

- Three .02 meg. (20,000 ohm) Lynch metallized pigtail resistors.
- One Electrad 150-ohm flexible biasing resistor.

### Other Parts

- One 5x6½ inch panel.
- One cabinet to fit (walnut finish wood).
- Three 5/8 inch milled threaded bushings.
- One Benjamin switch.
- Four wire outleads, 6 ft. long: yellow, blue with yellow tracer, brown and red.
- One REL vernier dial, 20-to-1 reduction ratio; dial hardware.
- Hardware: One dozen 6/32 brass nuts, one dozen 6/32 screws ½-inch long.

# Short-Wave Converter Di

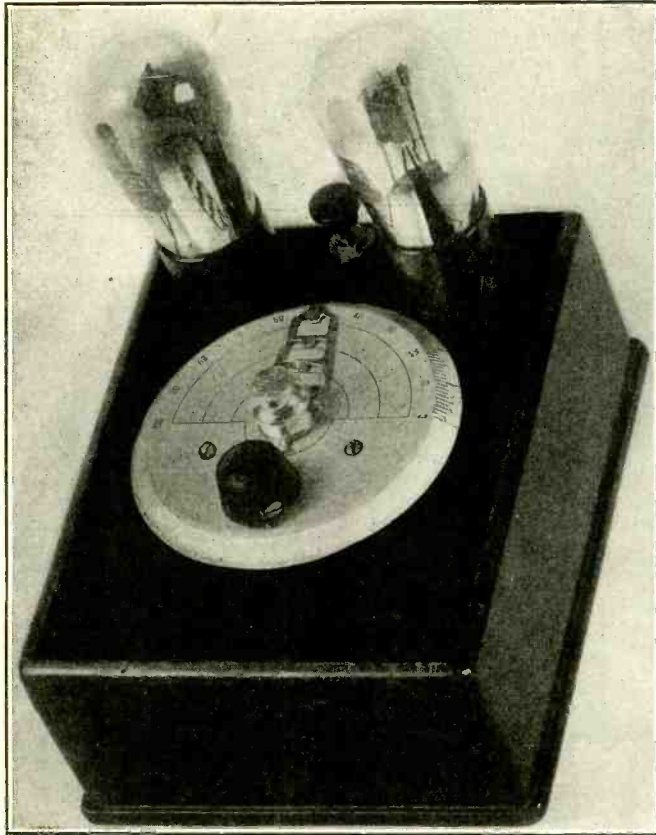

Fig. 2

The coil switch is at rear, between the pair of 227 tubes. Call letters or frequencies may be written directly on the dial.

(Continued from preceding page)

value gives a time constant of 2 micro-seconds, hence it takes two one-millionths of a second for the condenser to discharge to a little less than half its original charge. With a small time constant the amplification is good on high frequencies.

### How to Wind the Coil

Simplification is achieved by use of only one tuned circuit, as the broadcast receiver should be selective enough to render the selectivity of the combination high. In fact, if the receiver is selective enough for broadcast use, then it is bound to be selective enough when the set and the converter are worked together. Also, the sensitivity of the receiver greatly affects the sensitivity of the combination.

Another factor working toward excellence of results is that the coil is wound with large sized wire on the secondary. No. 18 enamel wire is used. The size of wire for the tickler winding and for the pickup winding is not important, as fine wire will do, but it is convenient to make a tap on the No. 18 wire winding for pickup connection: ground connection, so that the 1½ turns serve for coupling modulator and oscillator.

There is another tap on the No. 18 wire winding, and this is for the coil switch. Instead of using plug-in coils, a fixed coil is used, and this tap permits tuning in higher frequencies than when the switch is in "off" positions. The wavelength coverage is 20 to 135 meters, at an intermediate frequency around 1,500 kc.

Get a piece of bakelite tubing, 1¾ inches diameter, 1½ inches high, and drill a hole for 6/32 machine screw, which can be done with a No. 28 drill, or use a No. 30 drill and a 6/32 tap if you want to avoid using a nut later. This hole is ¼-inch down and is for mounting the grid condenser.

On the opposite side of the diameter, ½ inch down, drill for the anchorage holes of the No. 18 wire and leave 6-inch excess for projecting leads. Wind 4½ turns, twist a loop for a tap, wind nine more turns, twist a loop for a tap, and wind 1½ more turns. Terminate with a lead 6 inches long. Leave ⅛-inch space and wind 15 turns of No. 24 single silk covered wire for the tickler. Both windings are in the same direction. Leave 6-inch excess leads from terminals of tickler also. The wire protrusions are to be cut down to size later.

Drill for a 6/32 machine screw on the same line as the other

hole of the same size, also ¼-inch from the coil form rim, but of course from the opposite end. A small bracket fastens to this second hole, so that the coil form may be mounted on a bushing attached to the inside screw of the modulator socket.

### Connections for Coil

The windings as constituted now are, for the following connections: Beginning of No. 18 wire winding to grid of the oscillator; tap 4½ turns down, for switch; tap 13½ turns down, for ground; other terminal of No. 18 winding for connection to cathode of the modulator.

The tickler is connected with B plus to the terminal that adjoins the No. 18 wire winding, and extreme outside terminal of tickler to plate of the oscillator.

To avoid body capacity, even on the highest frequencies receivable, ground the tuning condenser on the side nearer the front panel, which can be done by soldering carefully to eyelets which are on either side of the rotor shaft.

As for carrying the ground lead, take the brown wire that is to go from converter to ground post of the receiver, solder it to the shield of one of the three-in-one condenser blocks. Connect another lead from a corner of this shield to nearer eyelet at panel. Run a similar lead from the other eyelet to the case of the other condenser block. If the grounding of condenser is done only at the rear of the condenser (farthest from where the hand will be in tuning), then slight body capacity may develop on the higher frequencies, when the switch is cut in, due to a voltage rise across the shaft.

The condenser used was the new Hammarlund junior midline type, made especially for such short-wave use, and which, when driven by a high ratio vernier dial, gives as fine a result as is possible.

### Write Log on Dial Front

The vernier dial has a reduction ratio of 20-to-1, which is as high a ratio as is obtainable in commercial dials. Besides having the usual 0 scale a scale in units of 1, from 100 to 0, it has two ruled spaces in which call letters may be written. The upper space may be used for the stations tuned in with coil switch in, and the lower for those received with coil switch out. Then the physically higher row on the dial will refer to higher frequencies, and the lower row to lower frequencies. There is a third space available, at bottom, but too cramped to be of much practical value.

Instead of call letters, of course, frequencies may be written in. It must be remembered that the converter logging will not hold unless the same intermediate frequency is used subsequently, that is, the set is tuned to the same frequency. As the intermediate frequency is lowered, the frequency of short-wave signal response is increased, so as you increase capacity in the tuned circuits of the set you must do likewise with the tuned circuit of the converter.

The dial has a brass frame finished in dull silver, with a nickel-finish brass pointer. Indices on the pointer refer not only to the engraved numerical settings, but also individually to the rows for marking.

The direction of the dial scale is such that the condenser should be counterclockwise, that is, capacity should increase as the shaft of the condenser is turned to the left. The dial has end stops, so if you use a condenser that has none, you get stopping effect just the same, although the Hammarlund condenser has end stops, as well as a screw near the front for tension adjustment.

The brass frame of the dial affords an extra precaution against body capacity, as it constitutes a shield plate. The dial is grounded automatically by virtue of contact of its hub and set-screw with the condenser frame.

The first things to mount are the two condenser blocks. Each of these consists of three 0.1 mfd. condensers, in one case, with common block lead representing one side of all three capacities, and the three red leads representing the individual other sides of the respective capacities.

The panel dimensions, Fig. 3, take care of all requirements. The two small holes that would seem to be inside the 4-inch diameter of the dial certainly are, but the dial is of the raised type, and has a corresponding free space underneath, so that the nut may be affixed to the screw built into the condenser block, without danger of obstruction.

### Mounting Difficulty Avoided

Next mount the Hammarlund condenser, with frame parallel to the narrow width of the panel, and so that the plates move in the direction of the sockets. Then slip on the dial, not fixing the set-screw, and loosely attach the non-obstructed nut to one dial screw. Then turn the Hammarlund condenser frame counter-clockwise, so as to disengage its mounting nut, until the condenser is at right angles to the position it occupied before. Now loosely affix the other dial nut, pull the screw

# ps Below the Noise Level

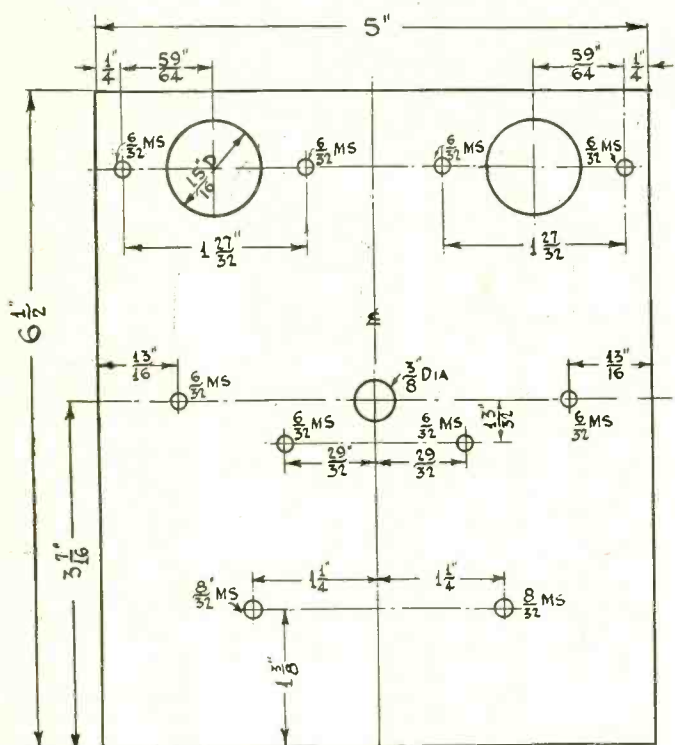

Fig. 3

Dimensions for drilling the panel for the circuit diagrammed in Fig. 1.

head out from the dial at front panel until the nut is against the back of that panel, turn the Hammarlund condenser back to the position previously occupied, whereupon it will be tightly mounted again, and tighten down both dial screws from the front panel.

The winding of the coil, as given, makes for shortest leads, as the terminals and taps come out at convenient places. For instance, the coil switch tap is near the switch, and the plate lead is right near the oscillator plate.

The 0.2 mfd. is constructed of two red leads connected together, while 0.3 mfd. is three red leads interconnected.

### Avoid Condenser's Field

When the wiring of the converter is completed, glance over the leads and be sure that no plate or grid lead is near the tuning condenser. The grid of the oscillator is connected to one of the stator lugs of the condenser, but the lead goes in a direction away from the condenser, and is out of the field. If the modulator grid lead, for instance, is in the field of the condenser, reception scarcely will be possible.

Use only one lug for oscillator grid connection to the condenser, and connect the grid prong of the oscillator socket to the coil terminal projection near the winding form, scraping off wire insulation for soldering.

The filament transformer is mounted to the front panel by two threaded bushings attached to the screws of the transformer, the screws through the front entering the free side of the bushings.

### How to Connect Up

The leads from the converter consist of four:

You may braid the leads from the converter.

(1)—Remove the aerial from your receiver and connect it instead to the yellow lead of the converter.

(2)—Connect the brown converter lead to the ground post of your set, but leave the ground attached to the set.

(3)—Connect the blue-with-yellow-stripe converted lead to the vacated antenna post of the receiver.

(4)—Connect the red converter lead to B plus 50 volts or more, even up to 180 volts, whichever is most accessible from your set.

### Operation Explained

If in doubt as to how best to obtain this positive voltage from your set, ask the concern from which you bought the set, or write to the set manufacturer. If you built the set yourself, of course, you know this connection.

As for operation, you yourself must select the most suitable

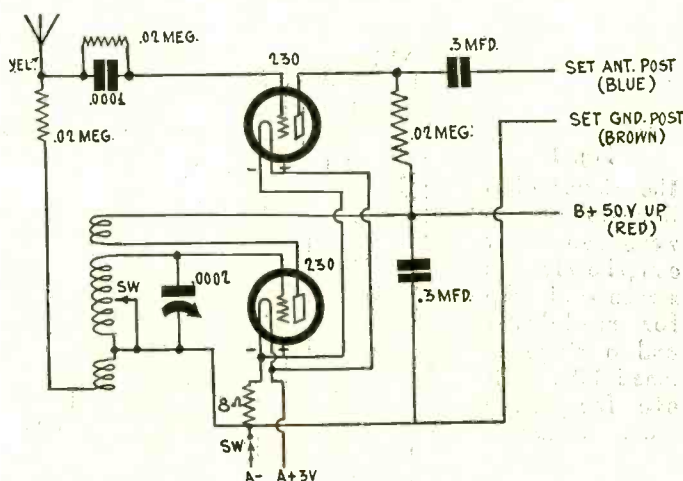

Fig. 4

The battery model converter, equal in performance to the AC model, is wired as shown in this diagram.

intermediate frequency. This will be gleaned from experience. Most receivers now in use are more sensitive at the higher frequencies. Of late sets, particularly those in the 1930-31 production class, the opposite is true. If your receiver is so sensitive that you pick up broadcasting at almost all dial points in the broadcast band, select either extreme (highest or lowest set dial position), whichever is the more sensitive, and stick to that, or, if your set is very sensitive but does not exceed the broadcast band at both extremes, use the one extreme at which the receiver does tune beyond the broadcast limit.

Only after your intermediate frequency is established to your satisfaction should you write down the call letters or frequencies on the converter dial. This determination of satisfaction can not be made on the basis of a single evening's trial, but only after a really good condition for short-wave reception prevails, which you will easily recognize by the many more stations that come in, compared to other occasions, and the enormously increased volume of all stations received.

### List for Check-Up

Short waves have peculiar habits. They skip certain distances, they zoom around the world one night and bottle up tight on the same frequencies the next day or night, and they do not travel as well on some frequencies as on others. However, for purposes of tests, it is easy to confine one's work to the broadcasting stations that relay short waves. The following is the list of principal stations:

Meters	Kilocycles	SW Call	Broadcast Call
16.873	17,750	W8XK	KDKA, Pittsburgh, Pa.
19.557	15,320	W2XAD	WGY, Schenectady, N. Y.
19.724	15,200	W8XK	KDKA, Pittsburgh, Pa.
31.35	9,570	W1XAZ	WBZ-WBZA, Springfield, Mass.
31.48	9,520	W2XAF	WGY, Schenectady, N. Y.
48.86	6,140	W8XK	KDKA, Pittsburgh, Pa.
49.02	6,110	W2XE	WABC, N. Y. City (Columbia Broadcasting System)
49.18	6,100	W3XAL	WJZ, New York City
49.34	6,075	W9XAA	WCFL, Chicago, Ill.
49.5	6,050	W8XAL	WLW, Cincinnati, O.
49.5	6,050	W3XAU	WCAU, Philadelphia, Pa.
49.83	6,010	W9XF	WENR, Chicago, Ill.

### A LIST OF PARTS

#### Coils

One tapped short wave coil.

#### Condensers

One .0001 mfd. fixed condenser.  
One .0002 mfd. Hammarlund variable condenser.  
Two .3 mfd. fixed condensers.

#### Resistors

Two .02 megohm fixed resistors.  
One 8 ohm fixed resistor.

#### Other Parts

Two four-prong tube sockets.

# Shooting Trouble

By Brunster

Fig. 1  
The circuit of a three-tube short-wave converter employing a screen grid tube for modulator and a stage of tuned intermediate frequency amplification.

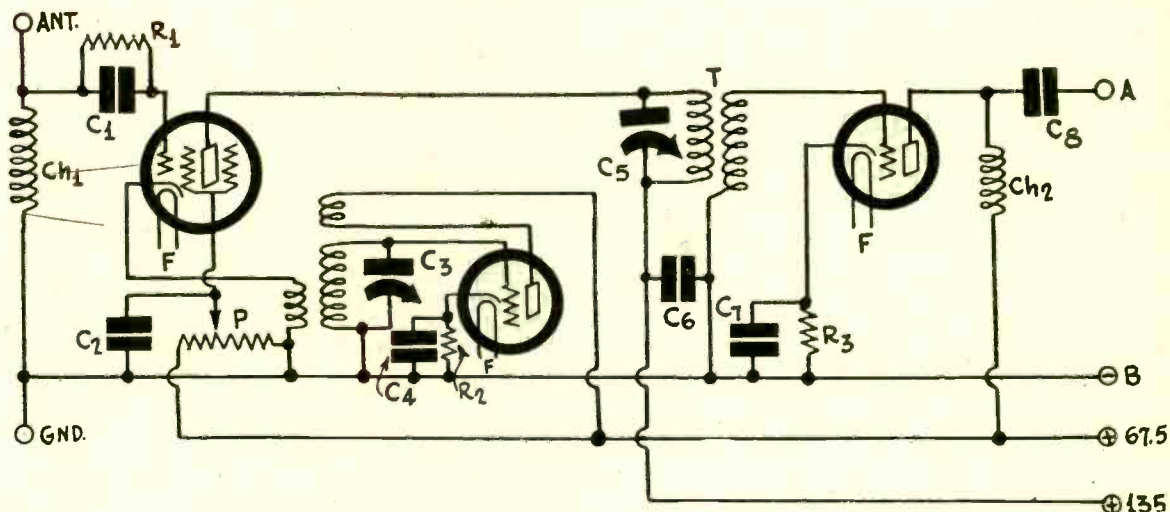

If we are to judge by reports on short-wave converters, it is only those that have been wired "exactly" according to the diagram that fail to work, and more particularly those that have been checked "three" times, either by the builder himself or the local expert.

Just a few days ago one of the short-wave converters assembled by a fan was brought in with the report that it was wired exactly according to the diagram, that it had been checked the conventional number of times, and that in spite of this it did not bring in a peep. This converter was turned over to a technical man for checking and correcting and he found quite a few mistakes, some of which were quite glaring. The circuit was then rewired exactly as the diagram called for and tested, and it did bring in plenty of short-wave stations. It was turned over to the owner, who returned within 24 hours with the report that he had received a couple of European stations.

Of course, not every short-wave converter on every broadcast receiver will bring in European short-wave stations. Such reception should not be expected, but gratefully received when it is achieved. Code stations, of course, come in from all over the world but not all fans can identify them and therefore they are not counted. One fan who got a short-wave converter even reported that it did not work because it brought in a preponderance of code! Any receiver or converter that brings in code works.

## Troubles Encountered

Some troubles are met in short-wave converters. In the first place they are noisy, or rather, they bring in a lot of noise. This is not the fault of the converters, because they bring in noise only when distant stations are being received, or when sensitivity is adjusted for the reception of distant stations. Any receiver will do the same thing, for the noise is in the air. Another thing is that they do not work so well with some superheterodynes as with tuned radio frequency amplifiers. The reason for this is that there is practically no radio frequency amplification ahead of the first detector in most superheterodynes. In the latest superheterodynes, however, there is amplification ahead of the first detector and with these receivers the converters do work well.

Still another difficulty is that some of the converters bring in broadcast stations on top of the short-wave stations. There are two reasons for this. First, there are harmonics of broadcast stations which fall in the short-wave band. The converters bring them in because if they did not they would not be operative. A converter does not care where or how a signal originates. Again, harmonics are generated in the receiver and these are brought out strongly by the converter. The fault is in the receiver, not in the converter.

Second, the broadcast receiver picks up stations directly by the antenna effect of the various coils and leads. This is partly the fault of the receiver and partly of the converter. Select an intermediate frequency free from direct reception of any station in the broadcast band.

## Acts as Broadcast Booster

When the converter acts as a booster of broadcast signals only, the oscillator in the converter is not working. Moreover, the coupling devices in the converter are such that they are effective also on broadcast waves. This is more or less in-

evitable because the short waves and the broadcast waves meet at 1,500 kc. If it is not desired to receive the frequencies around 1,500 kc and immediately above, the coupling devices can be chosen so that very little broadcast signals gets through.

The converted is somewhat more sensitive on short waves when the coupling devices are such as to be effective on broadcast waves also. This is particularly true when resistances are used for coupling impedances. In Fig. 1 we have a typical short-wave converter in which the first coupler is a choke coil Ch. 1. If this is replaced by a high resistance, the sensitivity will be somewhat higher, but will be the increased interference from broadcast stations.

The choke should not be made too large for then the broadcast stations will get through just the same. The best coupler from the point of view of interference is a tuned circuit, but this unfortunately increases the complexity of the converter and the gain is hardly sufficient to offset the disadvantages. A quarter millihenry choke, or one even smaller, has been found to be quite satisfactory.

## Tuned IF Transformer

A tuned transformer T between the modulator tube and the intermediate frequency amplifier is a great aid in eliminating broadcast signals from the output when they are not wanted. Moreover, is a great aid in increasing the sensitivity of the

# International Tests

Boston, Mass.

Starting February 1st, station W1XAZ, the short-wave station of Westinghouse Electric and Manufacturing Company, Boston, Mass., will broadcast programs dedicated to members of the International Short Wave Radio League and short-wave listeners in different countries throughout the world.

Listeners are urged to make special effort to pick up these daily broadcasts and report the results of their reception as soon as possible directly to the International Short Wave Radio League, Jamaica Plain Station, Boston, Massachusetts, U.S.A. Any comments with regard to the strength of the signals, fading, or other transmission phenomena will be greatly appreciated.

W1XAZ transmits daily on 9,570 kilocycles (31.35 meters), from 1200 to 0400 G.M.T. and relays WBZ, Springfield, Mass., and WBZA, Boston, Mass. Following is the schedule of the times at which these special broadcasts to the different countries will be made:

1200 to 1400 G.M.T.: To Central and South American countries, Siam, Dutch East Indies, Philippine Islands, Japan and Australia.

1700 to 1800 G.M.T.: To British East Africa, Madagascar, India, Siam and French Indo-China.

1900 to 2100 G.M.T.: To Great Britain, Spain, Portugal, France, North Africa, West Africa, Italy, Scandinavia, Netherlands, Germany, Central European countries, South Africa, British East Africa India and Australia.

2300 to 0200 G.M.T.: To Great Britain, India, Siam, French Indo-China, Dutch East Indies, Philippine Islands, Japan, South and Central American countries.



# in S W Converters

Brunn

converter. The tuning of the primary of the transformer with C5 makes the modulator very effective and at the same time it puts a high signal on the final tube.

This tuned circuit does not add to the complexity of operating the circuit for it is tuned only once, or each time it is desired to try a different intermediate frequency. There is no good reason why this should be changed often, because once the best frequency has been found, that frequency at which the broadcast receiver is most sensitive and at which there is no interference, it does not have to be changed any more. Neither does the tuning of the receiver.

The intermediate frequency tuner eliminates interferences because the high frequencies are shunted out by the condenser and the low by the inductance, and the only frequency which is transmitted is that to which the tuner is adjusted. If the coupler between the last tube in the converter and the broadcast receiver be shielded and the leads be made short, there is little chance of interference being picked up at this point. Naturally, if the lead from the converter to the broadcast receiver antenna post be made several feet long, just as much broadcast signals will be picked up as if a wire of this length were used as antenna. In many receivers a wire of this length is sufficient to pick up all the local broadcasters and some distant ones besides. Hence it is important to make this lead short or to shield it.

### By-passing Necessary

By-passing of the low frequency leads is essential because these leads also can act in the aggregate as an antenna. This by-passing refers to the voltage divider controlling the screen voltage on the modulator, the bias resistors of all the tubes, and the B supply leads.

Another source of trouble with a short-wave converter is overloading of the modulator by the oscillator. There is a great temptation to adjust the circuit so that this might occur because the closer the oscillator is coupled to the modulator the more sensitive is the converter. If the pickup coil should contain too many turns and be placed too close to the resonant circuit of the oscillator, overloading of the modulator is likely. To avoid it we have to sacrifice some of the sensitivity. Overloading of this kind is evidenced by a roaring sound in the receiver.

### Tune Carefully

Careful tuning of the converter is an essential if distant stations are to be received because if the broadcast receiver is

very selective the converter will appear to be much more selective still and it is easy to pass over stations without noticing them at all. When distant stations are being sought the sensitivity should be turned up to the maximum and the dial explored carefully and slowly. Once in a while a strong station will roar in so strong that everything will be overloaded. Pass over it quickly without turning the dial too far, for close to that strong station may be a weak station. After the desired station has been located tune it in as accurately as possible and then adjust the volume either with the volume control associated with the converter or with that in the broadcast receiver.

There are many broadcast receivers utilizing a loop for tuning the input. How is a converter to be connected to such a set? If the output circuit of the converter is such as is illustrated in the diagram herewith, and most of them are that way, connect the high potential side of the output to the high potential side of the loop and join the grounded sides of the two together also. The high potential side of the loop can usually be found by inspection for it is that side which is ultimately connected to the grid of the first tube, or to the stator plates of the first tuning condenser in the receiver. If the leads cannot be traced convenient connect the two output terminals to the two sides of the loop and note what happens when the converter condenser is turned. If no signals come in reverse the two connections. The high potential side of the converter output, of course, is that which goes to the plate of the last tube, through the stopping condenser.

### No Oscillation

If the converter fails to work and it is known that the circuit has been wired correctly, chances are that the oscillator is not functioning and this is probably due to lack of plate voltage or lack of sufficient filament voltage on the oscillator tube. Measure the voltage on the filament or heater and make sure that it is equal to the rated voltage. If the voltage should turn out to be just a little under the normal it is usually possible to start oscillation by increasing the plate voltage on the tube.

It is assumed that the leads to the oscillator coil have been connected correctly for oscillation. If they are not, of course, no amount of juggling the voltages will cause oscillation. To insure that the leads are connected correctly make sure that the grid and the plate leads are far apart and that the ground and B plus terminals are near together, the two windings being in the same direction. It makes no difference how the pickup coil is wound just so it is connected in one of the approved ways, in the cathode circuit as illustrated, in the grid circuit, or in the screen circuit.

The grid leak method of detection illustrated has been found to be very effective. The condenser in the grid lead is usually a little smaller than the condenser used in broadcast detectors, and the grid leak may also be smaller. The best detecting efficiency can usually be found quickly for any combination by adjusting the voltage on the screen by means of the potentiometer.

## from W1XAZ

For those who do not like to figure out the local time from the G.M.T. we append the following conversion table for the five standard American time zones:

G.M.T.	A.S.T.	E.S.T.	C.S.T.	M.S.T.	P.S.T.
0000	8 P.M.	7 P.M.	6 P.M.	5 P.M.	4 P.M.
0100	9 P.M.	8 P.M.	7 P.M.	6 P.M.	5 P.M.
0200	10 P.M.	9 P.M.	8 P.M.	7 P.M.	6 P.M.
0300	11 P.M.	10 P.M.	9 P.M.	8 P.M.	7 P.M.
0400	12 M.	11 P.M.	10 P.M.	9 P.M.	8 P.M.
0500	1 A.M.	12 M.	11 P.M.	10 P.M.	9 P.M.
0600	2 A.M.	1 A.M.	12 M.	11 P.M.	10 P.M.
0700	3 A.M.	2 A.M.	1 A.M.	12 M.	11 P.M.
0800	4 A.M.	3 A.M.	2 A.M.	1 A.M.	12 M.
0900	5 A.M.	4 A.M.	3 A.M.	2 A.M.	1 A.M.
1000	6 A.M.	5 A.M.	4 A.M.	3 A.M.	2 A.M.
1100	7 A.M.	6 A.M.	5 A.M.	4 A.M.	3 A.M.
1200	8 A.M.	7 A.M.	6 A.M.	5 A.M.	4 A.M.
1300	9 A.M.	8 A.M.	7 A.M.	6 A.M.	5 A.M.
1400	10 A.M.	9 A.M.	8 A.M.	7 A.M.	6 A.M.
1500	11 A.M.	10 A.M.	9 A.M.	8 A.M.	7 A.M.
1600	Noon	11 A.M.	10 A.M.	9 A.M.	8 A.M.
1700	1 P.M.	Noon	11 A.M.	10 A.M.	9 A.M.
1800	2 P.M.	1 P.M.	Noon	11 A.M.	10 A.M.
1900	3 P.M.	2 P.M.	1 P.M.	Noon	11 A.M.
2000	4 P.M.	3 P.M.	2 P.M.	1 P.M.	Noon
2100	5 P.M.	4 P.M.	3 P.M.	2 P.M.	1 P.M.
2200	6 P.M.	5 P.M.	4 P.M.	3 P.M.	2 P.M.
2300	7 P.M.	6 P.M.	5 P.M.	4 P.M.	3 P.M.
2400	8 P.M.	7 P.M.	6 P.M.	5 P.M.	4 P.M.

## Radio World Advertising Rates

	1 Inser.	4 consec.	13 consec.	26 consec.	52 consec.
		Inser. (each) 10%	Inser. 12 1/2%	Inser. 15%	Inser. 20%
1 page	\$150.00	\$135.00	\$131.25	\$127.50	\$120.00
1/2 page	75.00	67.50	65.62	63.75	60.00
1/4 page	50.00	45.00	43.75	42.50	40.00
1/8 page	37.50	33.75	32.81	31.87	30.00
1/16 page	25.00	22.50	21.87	21.25	20.00
1/32 page	18.75	16.87	16.41	15.94	15.00
1 inch	5.00	4.50	4.37	4.25	4.00

Classified advertisements, 7 cents a word; \$1.00 minimum; remittance with order.

### Advertising Department

Radio World, 145 West 45th St., New York, N. Y.

# Right or Wrong?

## First Try to Reply Correctly Before Reading the Answers

### Questions

(1)—There can be no feedback through a grid bias resistor used in common by several radio frequency amplifiers when a by-pass condenser is connected across the resistance.

(2)—When the plate current required by a receiver is greater than one 280 tube can supply it is all right to connect two of them in parallel. Each tube will then supply one half of the total load and neither tube is overworked.

(3)—When a radio receiver develops a bad hum and when the B supply of that receiver contains electrolytic condensers the most probable cause of the hum is a defect in the condensers.

(4)—When the secondary of a push-pull input transformer is split and a condenser is connected between the two low potential ends and a high resistance is connected from each winding to B minus, the condenser must be enormously large if the response on the low notes is not to be cut down excessively.

(5)—When there are two windings of the same voltage on a transformer these two windings may be connected in series to double the voltage and they may also be connected in parallel so as to double the current capacity of the windings, assuming they are equal in respect to current capacity as well as to voltage.

(6)—The time constant of a stopping condenser and a grid leak resistance is a measure of the amplification at low frequencies and the larger the time constant the greater will be the amplification on the low frequencies.

(7)—If a condenser is connected across a resistance for the purpose of reducing the impedance the capacity must be larger the lower the resistance.

(8)—Shorting one turn on a radio frequency coil that is tuned lowers the selectivity of the circuit formed by the condenser and the coil, but shorting many turns has little effect because the inductance of the short circuit is so great that practically no current can flow in it.

(9)—If a short-wave converter operated with a given sensitive receiver brings in stations 1,000 miles away, it is just as likely to bring in stations 5,000 miles away.

(10)—The sensitivity of a short-wave converter is mostly a matter of sensitivity of the receiver with which the converter is used.

(11)—If the upper oscillator setting (higher frequency) is used in a short-wave converter and a given station is tuned in with the broadcast receiver set at 1,500 kc, stations of higher frequency will be tuned in if the oscillator is left alone and the broadcast receiver is tuned to lower frequencies.

(12)—A microphone makes use of the fact that the air particles move rapidly to and fro when a sound wave passes. That is, the movement of the diaphragm of the microphone follows the motion of the particles of air.

(13)—If the oscillator in a short-wave converter is closely coupled to the modulator there is grave danger of overloading the broadcast receiver by the oscillator long before weak signals are built up to audibility.

(14)—An electric time clock attached to a radio receiver makes a noise because the brushes produce sparks.

(15)—When a station interferes with another station having twice the frequency of the first, the first transmits a good deal of its total energy on the second harmonic.

(16)—Ganging of the oscillator and modulator condensers in a short-wave converter with plug-in coils, or any superheterodyne with plug-in or coils variable in steps is not practical because different rates of change of capacity are needed for the different inductances.

### Answers

(1)—Wrong. There will be feedback if there is any common impedance between two circuits. Whether this feedback is such as to cause an increase in the amplification or a decrease depends on the phase of the feedback. A condenser across a bias resistor does not reduce the common impedance to zero no matter how large the condenser. The safest way to avoid feedback in this manner is to use a separate bias resistor for each tube and to by-pass each separately. The feedback that may remain in this case is such as to stabilize the circuit.

(2)—Right. Two equal tubes can be connected in parallel and when so connected each tube will assume half the load. If, however, one of the tubes has a higher internal resistance it will let the other tube do most of the work. Hence when connecting two tubes in parallel it behooves the operator to select equal tubes. A small percentage difference makes no difference.

(3)—Right. Some electrolytic condensers deteriorate rapidly

when subjected to high voltages and heat, and afterwards they cease to be effective as by-pass capacities. Hum results.

(4)—Wrong. The condenser may be quite small and one of 2 mfd. is sufficient even if the amplifier is to be effective as low as 30 cycles. The reason for this is that it is connected across a high resistance, the sum of the two resistances connected from the low ends of the transformer to ground.

(5)—Right. Two windings may be connected in series so that the voltages of the two add up and they may be connected in parallel so that the current capacities of the two add up, but they may also be connected in series so that the voltage is the difference between the two voltages and they may be connected in parallel so that the two windings are short-circuited. When connecting windings in parallel great care should be exercised to prevent this short-circuit, for it may cause great damage.

(6)—Right. It is a measure of the amplification, provided it is interpreted correctly. For full amplification on the very low audio notes the time constant should be large, say .02 second or larger, and this should be obtained by making the resistance of the grid leak as large as possible.

(7)—Right. The total impedance of the condenser and the resistance in parallel depends on the frequency in such manner that the higher the frequency the lower the impedance. The percentage reduction of the impedance depends equally on the capacity of the condenser, the resistance and the frequency. Hence for percentage reduction in the impedance of the resistance the product of the capacity, the resistance and the frequency should be constant. If any one is decreased, one of the other factors should be increased in the same ratio.

(8)—Right. When one turn is shorted a current is induced in this turn and this current is large because both the resistance and the inductance of the turn are low. When many turns are short-circuited the resistance is increased in proportion to the length of the wire in the shorted portion and the voltage induced in the shorted circuit is also increased in the same proportion. However, the inductance of the shorted coil is increased approximately as the square of the number of turns. Hence the induced current is very much lower, proportionately, and the loss is decreased.

(9)—Right. When the distance between the receiver and the transmitter is between 1,000 and 5,000 miles the signals reported come from the sky, that is, they are reflected from the Heaviside-Kennelly layer and those originating 5,000 miles away will be reflected almost as well as those originating 1,000 miles away. At some times and at some places the signals from the more distant stations may be louder.

(10)—Right. Most converters simply convert the high frequencies into some lower frequency to which the broadcast receiver is tuned and when the converter is of this simple type the sensitivity is entirely dependent on the sensitivity of the broadcast receiver. If the converter has a high frequency amplifier, of course, the sensitivity will be increased, and if it has an intermediate frequency amplifier it will be increased still more.

(11)—Right. The frequency of the signal received is equal to the difference between the oscillator frequency and the intermediate frequency. If the oscillator frequency is fixed and the intermediate frequency is lowered it is obvious that the difference is increased and therefore that the frequency which the set tunes in is greater.

(12)—Wrong. The microphone responds to the variations in the pressure of the air as the wave passes. It is true that the velocity wave and the pressure wave are equal. However, the pressure is polarized while the motion wave is alternating. The pressure is the barometric pressure plus or minus a very small change while the motion of the air near the microphone is first in one direction and then in the other.

(13)—Wrong. There is danger of overloading the modulator but not of the intermediate frequency amplifier because, regardless of the relative values of the oscillation and the signal, the intensity of the signal in the intermediate frequency level is proportional to the product of the two and both the high frequencies entering into the combination are tuned out by the intermediate frequency filter.

(14)—Wrong. There are no brushes in an electric clock motor, for it is synchronous, and therefore there is no sparking.

(15)—Wrong. When there is interference of this type the cause is usually in the receiver. Either there is not enough selection ahead of the first tube to suppress the fundamental of the interfering station or the interference gets into the circuit after the first tuner. Distortion in the radio frequency tubes is the direct cause of the interference.

(16)—Right. It is possible to gang the oscillator to the RF tuners when there is a single coil, but when there are several it is not possible without sacrificing selectivity.

# Switching to Short Waves

## Plug-in Coils and Converters Present Other Means

**S**HORT-WAVE signals are brought in in many different ways, by short-wave receivers, converters, adapters. In one case plug-in coils are used, in others tapped coils. In the receiver illustrated the tap method is employed. In this receiver, which was described last week, a switch is mounted on the top of the shield can and this switch may be used for short-circuiting most of the turns in the coil which normally is large enough to cover the broadcast band. There is one switch on each coil. The first short-circuits the entire coil and the next three switches short-circuit all but 10 turns. Thus when these switches are operated the receiver is converted into a short-wave set, because 10 turns are just right to cover the most important part of the short-wave band with the tuning condensers in the circuit.

### TRF Short-wave Set

This is not a converter type short-wave receiver but a tuned radio frequency type because there is no oscillator in the circuit. The short-wave attachment is an extra feature of the receiver, the primary purpose being to receive broadcast waves.

Both the switches and the trimmer condensers are readily accessible so that the change may be effected in a minute or less. We mention the trimmer condensers in this connection because in order to get much selectivity on the short waves it is necessary to trim the circuit up for the short waves after the switching has been done. This is necessary not only because the switching will not adjust both the distributed capacity and the inductance in the circuits in different proportions but also because short-wave tuning is more critical.

### Oscillation Possible

There is a possibility of radio frequency oscillation in the amplifier after it has been changed to short waves and trimmed up, because the shielding may not be as effective at the short waves as at the long and also because the plate to grid capacity of a screen grid tube, though exceedingly small, may be sufficient to cause enough feedback to start oscillation. The trimmer condensers can be used to remedy this trouble if it

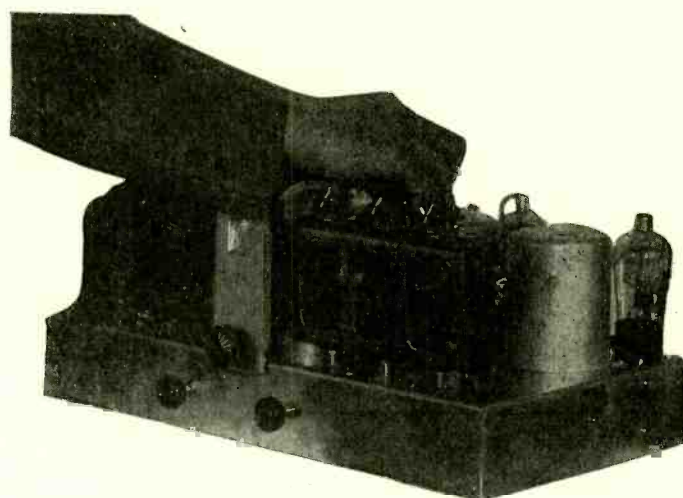

A switch is built into the top of each shield and is pulled to "out" position when short-wave reception is desired.

should occur, and to do so without greatly affecting the sensitivity.

### Operator Requirements

**W**HAT is the procedure required in order to become a radio operator at home and having my own receiving and sending station?—O.W.

The best way is to join a local amateur radio club and get in touch with those who are already active radio amateurs. Information may also be obtained from the American Radio Relay League, the national organization of radio amateurs, Hartford, Connecticut.

# FREE AID TO A NEW JOB!

SITUATIONS WANTED AND HELP WANTED ADVERTISEMENTS WITHOUT COST!

Address: Industrial Dept., RADIO WORLD, 145 W. 45th St., N. Y. C.

### SITUATIONS WANTED

**YOUNG MAN, 21 YEARS OF AGE,** desires position in experimental laboratory or factory. Has five years' experience as radio service man. Object is more experience rather than large salary. Will go any place in the United States. Harris A. Sprague, Jr., 48 Nelson Place, Worcester, Mass.

**YOUNG MAN, 19 YEARS OF AGE,** desires position in radio. Has had six years' experience in building broadcast sets, short-wave sets and transmitters. Interested in servicing and research work. George McClellan, 136 E. Arndt St., Fond du Lac, Wis.

**EXPERIENCED SET CONSTRUCTOR,** both short-wave and broadcast receivers. Man 20, desires situation. Harley Wood, Box 64, Fishers Island, N. Y.

**YOUNG MAN, 25 YEARS OF AGE,** with 7 months' training in short-wave at the McKim Radio and Electric School, Akron, Ohio. Would like work in laboratory of a radio manufacturing company. Very much interested in shortwave work. Willing to start at the very bottom and work up. Good character. John A. Williams, Box 13, Star City, W. Va.

**YOUNG ELECTRICAL ENGINEER,** 25 years of age, South American. Would like connection with radio manufacturing company to open branch in South America. Have references. D. C. Mendez, 236 Washington Ave., Brooklyn, N. Y.

**27 YEARS OF AGE, TECHNICAL GRADUATE** '23, experienced in radio work both in laboratory and in field, also in location department of large power company; speak, read and write Spanish; desire to locate in experimental work or in field; would consider location with some firm having branches in Spanish speaking locality. Good references on request. Address: Fairview, McKinley, Isle of Pines, Cuba.

**EXPERT RADIOTRICIAN,** trained and graduated by National Radio Institute, high school education, four years' experience in sales and service. Desires position with manufacturing firm. Karl C. Fischer, Gen. Delivery, Knoxville, Tenn.

**NATIONAL RADIO INSTITUTE STUDENT** wishes position in service and installation work. Jewell test equipment. Experienced in servicing. Willing to do any kind of work. Chas. C. Stutzenberger, 228 Turner Street, Allentown, Pa.

**YOUNG MAN, 10 YEARS' EXPERIENCE** in designing and building of radio production test equipment, production, designing home and automobile receivers, and elimination of ignition interference in motor radios, desires position with reliable company. Best of references. F. S. Palm, 5815 W. Roosevelt Road, Cicero, Ill.

**INVENTIVELY INCLINED,** and have diploma from Radio Training Association of America; would like to get in touch with radio factory with high-class laboratory. Former student in Electrical & Mechanical College of University of Kentucky. P. B. Kehoe, 2100 Lee Street, Fort Myers, Florida.

**YOUNG, ENERGETIC MAN;** several years' experience building and servicing sets. Has worked in Westinghouse & Electric Manufacturing Co. research laboratories. Excellent references. Free to travel. Not afraid of work. Desires location that will permit of carrying on schooling in pursuit of a degree. Russell J. Ramsey, Alpine Blvd., Wilkensburg, Pa.

**CERTIFIED RADIOTRICIAN.** Also high school graduate and at present C. R. E. I. student. Can furnish satisfactory references as to character and ability. Address: H. F. Goodrich, 2020 Seminary St., Dubuque, Iowa.

**YOUNG MAN, 33 YEARS OLD,** mechanical, electrical and radio knowledge and experience, technical education, seeks position at anything. Paul Weber, 1822 Bleeker St., Brooklyn, N. Y.

**SERVICE MAN,** five years' experience, with two of Chicago's largest servicing companies. 27 years old, A1 man, good references. Have finest test equipment. Will go any place. Robert Murray, 1520 Howard St., Chicago, Ill.

**YOUNG MAN 19, TECHNICALLY INCLINED,** desires a position as assistant in laboratory. High School education, several years experimenting with radio and chemistry; formerly radio operator; interested in research work. Melvin Kocher, Pershing, Ind.

**WANTED, SITUATION.** Experienced radio service man desires position. Call or write: Frank Lavalley, 218 Baxter St., Pawtucket, R. I.

# Matching Loudspeakers

By J. E. A

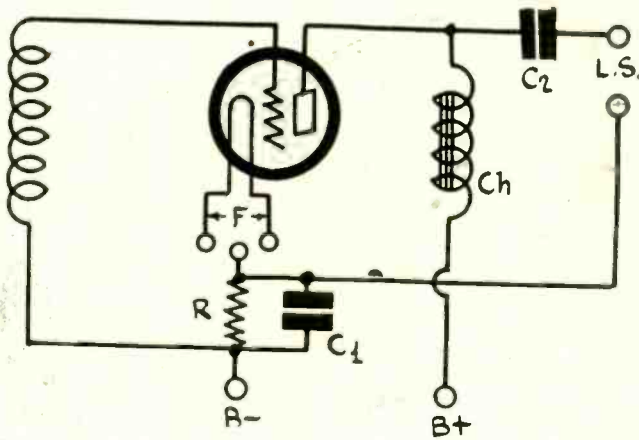

Fig. 1

An output stage, showing the type of coupling that is suitable for use with a high impedance loudspeaker.

QUALITY and quantity from a radio receiver depend to a great extent on the proper matching of the impedance of the loudspeaker and the output stage. Many loudspeakers have been condemned unjustly just because they were connected to the receiver in the wrong manner, or with the wrong coupling device. A common practice of testing speakers in radio stores used to be to connect them successively to the same output terminals, and they were put down as weak if the volume was feeble, strong if the volume was great, poor if the quality was unsatisfactory, and excellent if they were loud and of good quality. Undoubtedly, in many instances the worst speaker carried off the honors as the best of the lot.

If any speaker is to perform at its best it must be deriving its sound power from a source the impedance of which is equal to its own impedance and any comparison of speakers which does not provide for the proper coupling device for each is unfair. Entirely the wrong conclusion may be reached.

## Standardized Practice

The situation is not so bad now as it was formerly because there has been a certain amount of standardization. Power tubes now have approximately the same output impedance and speakers are made for this impedance. The 120 tube has an output impedance of 6,300 ohms, the 112A, around 5,000 ohms, the 231, 4,000 ohms, the 711A 2000 ohms, the 210, around 5,000 ohms, the 245, 1,800 ohms, and the 250, around 1,800 ohms. These may be divided into two classes, the 5,000-ohm class and the ohms, the 245, 1,800 ohms, and the 250, around 1,800 ohms. These may be divided into two classes the 5,000 ohm class and the 2,000 ohm class. A speaker designed to go with a tube in one class will not give good results if worked with one in the other because the matching is not correct. However, if a speaker designed to work with a tube in the high impedance class will give fairly good results if worked with a tube in the low impedance class.

A high impedance tube works well with magnetic and inductor magnetic speakers because these are usually wound to have a high impedance. These speakers, on the other hand, do not work well with low impedance tubes because their impedance is too high. Still, as was said above, they work better with the low impedance tubes than a low impedance speaker would work with a high impedance tube.

The above statements refer to cases when the speaker is connected directly to the plate circuit of the tube, that is, without a coupling transformer. By direct coupling is meant connecting the speaker in the plate circuit without any coupling device, or coupling it to the tube by means of a shunt choke and a series condenser. As soon as a transformer is used, the situation is different, for then we have to match the transformer to the tube and the speaker. The proper way of stating this is that we match the impedances of the tube and the speaker by means of the transformer. And the matching is largely a matter of ratio of turns on the matching transformer.

## Dynamic Speaker Matching

The voice coil of a dynamic speaker always has a low impedance and it could not be connected directly in the plate circuit of any available tube for the mismatching would be extreme. For this reason a matching transformer is always built into

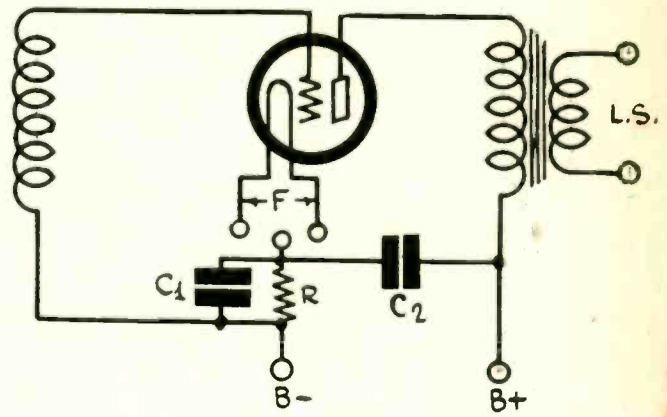

Fig. 2

An output stage, showing a transformer in the plate circuit. This is suitable for use with low impedance speakers, provided that the ratio of the transformer is such as to match the impedance of the tube to that of the speaker.

dynamic speakers. The ratio of turns on this transformer is such that whatever the impedance of the voice coil, the impedance of the primary, with the secondary connected to the voice coil, has the required value for the tube which is supposed to be used with that transformer. For greatest output the impedance is equal to the tube impedance, but for greatest undistorted output the impedance of the primary should be twice the impedance of the tube. No doubt, the actual impedance is somewhere in between in most cases, because greatest undistorted output is somewhat arbitrary.

When many speakers of different type and impedance are to be tested on different sets, it is best to have a matching transformer the ratio of which can be changed. There are such transformers available. They have taps on the secondary so that the ratio of turns may be changed as required.

Quite often an improvement may be effected by removing the transformer built into the dynamic speaker and substituting another which has a better characteristic. The change may not necessarily improve the ratio of turns but the frequency response of the amplifier. Usually the core of the substitution transformer is superior and the windings are made so that there is a negligible distributed capacity. Before changing the matching transformer it is best to consult the manufacturers of the transformer and request the best combination, specifying the speaker and the tube, or tubes, between which it is to function.

## Push-pull

A push-pull amplifier in most instances is used with an output transformer, and the primary of this transformer must be such that each half presents the proper impedance to the tube to which that half is connected. There must be twice as many turns on the primary of a push-pull output transformer as on one preceded by a single tube if the matching is to be correct, assuming that the speaker is the same in the two cases and also that the tubes in push-pull are the same as the tube in the single sided circuit. The reason is that the impedances of the two tubes add up.

In a few instances the loudspeaker is directly coupled to the tubes in a push-pull stage. In these cases also the impedances of the tubes add up so that the speaker impedance should be twice as great as if it were connected to a single tube by one of the direct methods of coupling. A magnetic speaker or an inductor dynamic may usually be connected from plate to plate of a push-pull stage of 171A, 245, and 250 tubes without any matching transformer, but when the tubes of higher impedance are used in this manner it is best to use a suitable coupling transformer even for these speakers.

## Circuits Illustrated

In Fig. 1 is illustrated one of the direct methods of coupling when a single tube is involved. In this case the impedance of the speaker should be equal to or larger than the impedance of the tube. Since magnetic and inductor speakers have high impedances, as a rule, either may be connected to the posts marked LS. If a dynamic speaker is to be used either the

# Speakers to Power Tubes

Anderson

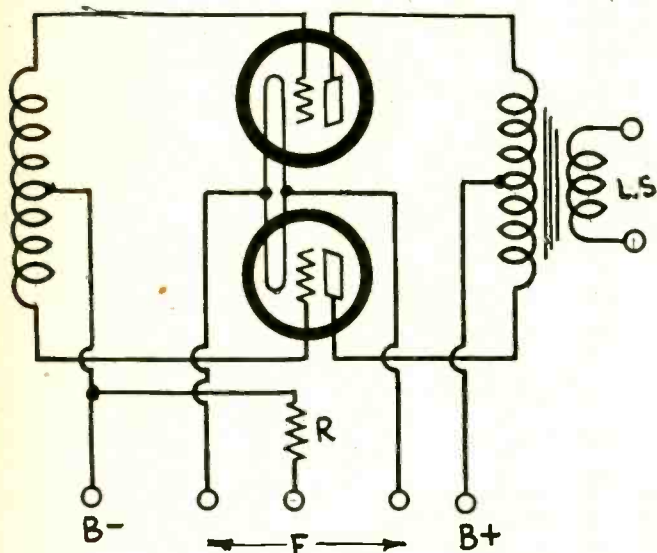

Fig. 3

A push-pull stage with output transformer, which is suitable for both high and low impedance speakers, provided that the ratio of turns of the matching transformer is right.

primary of the coupling transformer in the speaker must have an impedance equal to or somewhat greater than the impedance of the tube or else an additional matching transformer should be used to get most out of the tube and the speaker.

In Fig. 2 the transformer method of coupling is shown. The transformer shown may be the one that is built into the dynamic speaker, when LS signifies the terminals of the voice coil, or the transformer may be used in addition to the one built in. While it is not good practice for economical reasons to use more transformers than absolutely necessary sometimes improved results may be obtained by interposing an extra transformer between tube and the speaker. If this is to yield any improvement it is necessary that the matching be improved, so just any transformer cannot be used successfully.

If the tube in Fig. 2 is a large power tube and it is desired to operate a magnetic or inductor speaker, the transformer shown may be one of one-to-one ratio, in which case it is used only to keep the direct plate current out of the speaker.

### Push-pull Circuits

Fig. 3 shows a push-pull amplifier with transformer coupling between the speaker and the tubes. LS in this instance may be the terminals for magnetic or an inductor speaker, when the step-down ratio should be about two-to-one so that the secondary will have an impedance about equal to that of the speaker. LS may also represent the terminals of the voice coil of a dynamic speaker, when the secondary should have a low impedance. In this case the transformer may be the one built into the dynamic speaker or one substituted for it.

Fig. 4 is a diagram of a push-pull amplifier in which the loudspeaker is coupled directly to the two tubes. In this case the speaker must have a very high impedance because the impedance of the two tubes is twice that of either. Suppose, for example, that the tubes are 245s, each of which has an impedance of 1,800 ohms so that the total impedance is 3,600 ohms. Thus if the condition of maximum undistorted output is to be met the impedance of the speaker should be 7,200 ohms. A magnetic or inductor speaker suitable for coupling directly to a single tube of the 112A type is suitable here.

If an output transformer is used its primary impedance should be the same, namely, 7,200 ohms. However, when a transformer is to be used it is better to use the circuit in Fig. 3, for, as a rule, the fewer parts the better. This rule holds except when there is bad mismatching.

### Obtaining the Field Current

When a receiver is assembled by the fan the problem of getting the field current for the dynamic speaker usually arises. This problem should be answered before purchasing the speaker

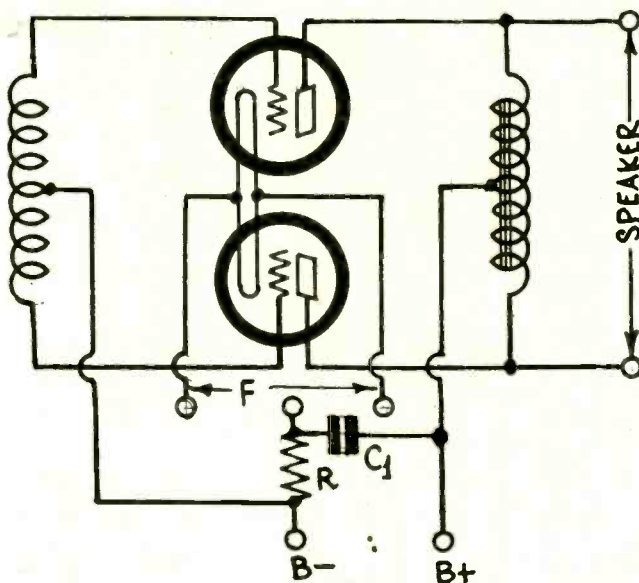

Fig. 4

A push-pull stage with direct coupling between the speaker and the tubes. This is suitable for high impedance speakers.

for it is then easier to coordinate the parts so as to obtain the field most economically. It is best to get a speaker in which the field current supply is provided for. The problem is then solved. If the receiver is operated from a storage battery a speaker requiring six volts for the field should be obtained. But if the receiver is AC operated it is better to get one that has a high voltage field so that the current may be taken from the B supply.

The best manner in which to take the current for the field from the B supply depends on the design of the field. If the resistance is very high the field may be connected directly across the output. In other cases it may be connected in series with the supply and the field used as one of the filter chokes in the supply. This is common practice at this time for it makes the field winding serve two functions. As a rule, only part of the plate current required by the receiver is made to go through the field winding, that required by the power tubes being diverted. In other cases only the plate current for the power tubes flows through the field winding. The voltage drop in the field is then used as a bias for the power tube, or at least a part of the voltage drop is so used.

It is not practical to specify the best way of connecting the field unless all the facts are known, for example, the total voltage available, the total current required by the receiver and by the power stage alone, to total resistance in the field winding, and the current required for the field.

### Band Selector

WHAT is a band selector as used in a receiving set?—S.N.

A. It is a special tuning circuit which is designed to secure uniform radio amplification over a very narrow band of wave lengths. Usually a band of 10 kilocycles is chosen.

### Reliability of Voltmeter

IS a double scale voltmeter less reliable than two separate meters for covering the desired voltage?—V.W.J.

No. A little more care is required in using it so as not to apply a high voltage when the switch or button is set for a low voltage.

### Snow and Static

EVERY time a snowstorm starts we are bothered with a loud ticking noise in the receiver. What is the explanation?—T. L.

Static electricity collects on the aerial from the snowflakes and discharges to the ground. In your set a spark jumps through the antenna series condenser.

# Meter Usefulness Extended

## Milliammeters Made Into Voltmeters, and Voltmeter Ranges Increased

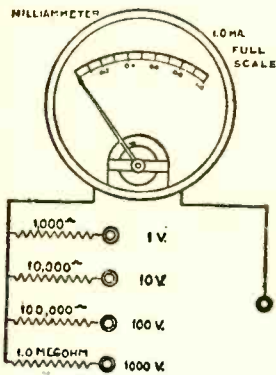

**Fig. 1**  
This drawing illustrates how to convert a 0-1 milliammeter to a multi-range voltmeter.

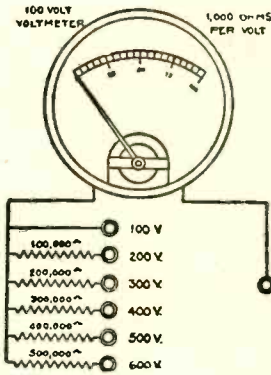

**Fig. 2**  
This drawing illustrates how to extend the range of a 0-100, 1,000 ohms per volt voltmeter to measure voltages up to 600 volts.

WITH a set of accurate and well-chosen resistance units, those who have a sensitive milliammeter or a microammeter can increase the usefulness of their instrument manifold, according to Francis R. Ehle, president of International Resistance Co. of Philadelphia. The same applies to those who have a good voltmeter, for they can increase the range of the instrument so as to measure accurately any voltage in a wide range.

The connections shown in Fig. 1 are intended for the conversion of microammeters and milliammeters into voltmeters. Those shown in Fig. 2 are for the conversion of a 100-volt, high-resistance meter to a multi-range voltmeter, by means of a number of precision wire-wound resistors serving as voltmeter multipliers. In using resistors of this type as voltmeter multipliers, it is essential that the internal resistance of the voltmeter be known, expressed in ohms per volt. Then multiply the full scale reading of the voltmeter by the number of ohms per volt, insert a similar value of resistor in series with the instrument, and said resistor will double the effective scale reading.

### Errors of Meters

The accompanying chart gives the total resistance required to change microammeters and milliammeters into instruments for accurately measuring voltage. Due to the fact that the resistance of most microammeters and milliammeters is very low, that is, 40 ohms or much less, these values may be used as the multiplying resistors. The error in this assumption is the resistance of the instrument divided by the resistance given in the table, which, in most cases, is very much less than the error in most calibrations. The maximum per cent error, other than the above, is the sum of the error of the moving element

and the per cent error in the resistance used. A moving element that is accurate to 2 per cent would never be more accurate, no matter how accurate the multiplier was made. On the other hand, if a high degree of accuracy is wanted and the moving element was designed for that type of work, a very accurate multiplier must be used. If closer accuracies than 1 per cent are required, it should be specified that resistors better than one-half per cent be provided.

Fortunately, wire-wound resistors of an accuracy of 1 per cent and less, are now available commercially, as contrasted with the wider tolerances of resistors of the past. Furthermore, these resistors are thoroughly seasoned. These perfected wire-wound resistors now make it possible to convert our meters into multirange instruments with every assurance of accurate readings.

The following table gives the pertinent factors:

### Use of Chart

The resistances given in the chart apply to the conversion of milliammeters and microammeters into voltmeters but not to the extension of the range of a voltmeter without making allowance for the resistance that is already connected in series with the armature coil of the moving element.

In the chart the left-hand column gives the desired voltage range, that is, the maximum voltage reading corresponding to full scale deflection, and the first row gives the sensitivity of the meter to be used. The most sensitive meter is the 0-100 microammeter and the least sensitive is the 0-5 milliammeter.

Let us illustrate the use of the chart. Suppose we have a 0-500 microampere meter and wish to convert it to a voltmeter having a maximum voltage reading of 500 volts. Resistances for the 500 microampere meter are given in the fifth column and those for a 500 volt range in the second row from the bottom. At the intersection of the row and column in question we find one megohm, which is the resistance that should be connected in series with the microammeter to convert it to the desired voltmeter.

It is well to note that the second row in the chart gives the sensitivity of the voltmeter, because the corresponding range is 0-1 volt and therefore the resistance given is the number of ohms per volt. The number of ohms per volt, of course, is determined by the sensitivity of the current meter, so that the first row also gives the sensitivity. If we take the reciprocal of the number of amperes given in this row we get the corresponding number given in the second row. Thus in the last column we find 5 milliamperes, or .005 amperes. If we divide unity by this number we get 200 ohms per volt, which is given in the last column and the second row.

To extend the range of a voltmeter it is necessary to know the total resistance of the meter, and the total resistance is obtained by multiplying the ohms per volt by the range of the meter. To extend the range this resistance must be taken into account in selecting the multiplier. In Fig. 2 the voltmeter has a range of 100 volts and a sensitivity of 1,000 ohms per volt. Therefore the total resistance in the meter is 100,000 ohms. To double the range we have to add another resistance of 100,000 ohms so that the total is 200,000 ohms. It will be observed that in Fig. 2 the multiplier resistance is always 100,000 ohms less than it would be if the meter were a milliammeter. The reason is that the 100,000 ohms is already in the meter.

Voltage Range Desired in Volts	RESISTANCE IN OHMS.									
	100 ua.	200 ua.	300 ua.	500 ua.	1,000 ua. 1 M. A.	1.5 M. A.	2 M. A.	3 M. A.	5 M. A.	
1	10,000	5,000	3,330	2,000	1,000	667	500	333	200	
1.5	15,000	7,500	5,000	3,000	1,500	1,000	750	500	300	
2	20,000	10,000	6,670	4,000	2,000	1,330	1,000	667	400	
3	30,000	15,000	10,000	6,000	3,000	2,000	1,500	1,000	600	
5	50,000	25,000	16,700	10,000	5,000	3,330	2,500	1,670	1,000	
7.5	75,000	37,500	25,000	15,000	7,500	5,000	3,750	2,500	1,500	
10	100,000	50,000	33,300	20,000	10,000	6,670	5,000	3,330	2,000	
15	150,000	75,000	50,000	30,000	15,000	10,000	7,500	5,000	3,000	
30	300,000	150,000	100,000	60,000	30,000	20,000	15,000	10,000	6,000	
50	500,000	250,000	167,000	100,000	50,000	33,300	25,000	16,700	10,000	
100	1 Megohm	500,000	333,000	200,000	100,000	66,700	50,000	33,300	20,000	
150	1.5 Megohm	750,000	500,000	300,000	150,000	100,000	75,000	50,000	30,000	
300	3 Megohm	1.5 Megohm	1 Megohm	600,000	300,000	200,000	150,000	100,000	60,000	
500	5 Megohm	2.5 Megohm	1 Megohm	1 Megohm	500,000	333,000	250,000	100,000 66,700	30,000 30,000 40,000	
1,000	Two 5 Megohm	5 Megohm	3 333,000	2 Megohm	1 Megohm	Two 333,000	Two 250,000	Three 111,000	Five 40,000	

# A 2-Volt Portable

By Einar Andrews

Fig. 1  
Circuit  
of 2-volt  
portable.

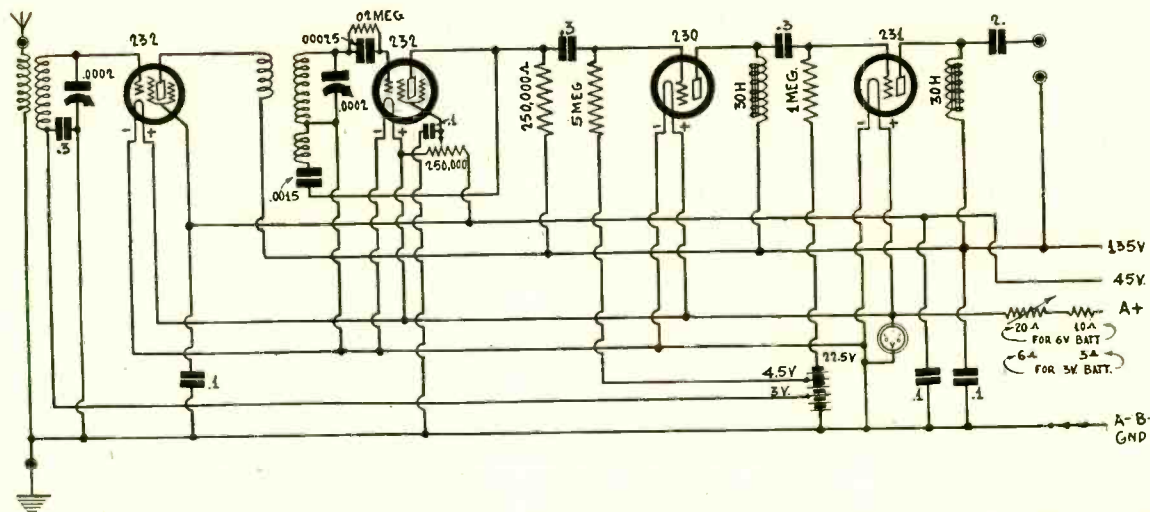

RADIO fans already are looking for circuits for use in building portable receivers to take along on camping, automobile, and motorboating trips. The first feeble sign of Spring turns the thoughts of these fellows to receivers of this type, for they want to be ready when the time comes.

A receiver that is to be used for this purpose must be portable whether it is to be carried by hand or by some mechanical means of transportation, and the portability must apply to the complete receiver, that is, to the circuit proper, the batteries, and the loudspeaker.

This year we are more fortunate in designing portable receivers than we have been heretofore, for now we have the two volt tubes with which to work, and with these tubes it is quite feasible to design a really good receiver that is neither too heavy to carry nor too costly to assemble and operate. We have the 232 screen grid tube to insure sensitivity, the 230 for audio frequency amplification, and the 231 for power. This power tube is large enough to operate a small speaker with plenty of volume. It should be realized that a portable receiver does not need to deliver as much sound output as a home receiver and the 231 will give more than is really needed.

We have in Fig. 1 a diagram of a four-tube receiver that is suitable for a portable set. The first tube is a 232 screen grid radio frequency amplifier, the second is a similar tube used for detection, the third tube is a 230 audio frequency amplifier, and the fourth is a 231 power tube.

Economy of operation is an important feature of any portable receiver. The present circuit is most economical, for the total filament current is only 0.31 ampere and the voltage source need not be higher than two volts. This means that the total wattage of the filament circuit is only 0.62 watts. However, a 2 volt battery is not convenient for carrying around, since it must be either a single storage cell or an air cell. Dry cells, perhaps, are most suitable for a portable set, and the lowest voltage in this case will be 3 volts, obtained by connecting two No. 6 cells in series. When this filament source is used the total wattage is 0.93 watt, the difference being taken up in the ballast resistor or rheostat. As indicated on the drawing, when a three-volt source is used a ballast resistance of three ohms should be used in series with a 6 ohm rheostat. The proper value of total resistance to use when the cells are fresh is 3.22 ohms. Accordingly, the 3 ohm ballast is almost sufficient and the rheostat can be used as a volume control. While the rheostat alone would be sufficient, the three ohm fixed resistance is used for safety. The voltage across the filaments, as read on the voltmeter, should never exceed 2 volts.

### Six Volt Source

When the receiver is to be used primarily on a car, or near a car, or in a motorboat, it is more convenient to use the six volt storage battery to supply the filament current. In this case the fixed resistance should be 10 ohms and the rheostat 20 ohms, as indicated on the drawing. The total wattage in this instance is 1.86 watts, but this is a small power to take from a storage battery.

Of course, B and C batteries are needed in addition to the A battery, and the B battery will supply a considerable power. The total plate current will be of the order of 15 milliamperes, and since the voltage is 135 volts, the power required is about 2 watts. Fifteen milliamperes is not a high current to take from a dry cell battery of a size that fits in well with the portability requirement. Three 45 volt blocks of medium size batteries will be sufficient.

Another feature that adds to the portability of the receiver is the midget tuning condensers employed. While each has a capacity of .0002 mfd. they are so small physically that they come well within the midget classification. Yet they are just as efficient as the large and clumsy condensers ordinarily used in broadcast receivers. To make these condensers cover the broadcast waveband it is only necessary to make the coils a little larger and to build the circuit so that the distributed capacity is the smallest possible. This means practically that no shielding should be used around the coils, or if some is used, that it should be far from the coils. The best arrangement, perhaps, is to put a shield half way between the two coils. However, no shielding at all should be necessary since there are only two tuned stages, and also since there is a means of controlling the regeneration in the detector circuit. The detector is in the form of a regenerative circuit but the feed back is not so much to make the circuit oscillate as to boost the amplification. Not all screen grid tubes will oscillate due to the fact the 250,000 ohm plate load resistance makes the effective plate voltage low.

### Grid Condenser Detection

The second screen grid tube is used as detector with stopping condenser and grid leak, the grid return being made to the negative end of the filament. The combination of .00025 mfd. (Continued on next page)

### LIST OF PARTS

#### Coils

- One antenna coupler as described
- One three-circuit tuner as described
- Two 30 henry choke coils

#### Condensers

- Two Hammarlund Midline Jr. .0002 mfd. tuning condensers
- One .00025 mfd. grid condenser with clips
- One .0015 mfd. fixed condenser
- Three 0.3 mfd. condensers
- Four 0.1 mfd. condensers
- One 2 mfd. condenser

#### Resistors

- One .02 megohm grid leak (or larger)
- One 250,000 ohm coupling resistor
- One 1 megohm grid leak
- One 5 megohm grid leak
- One 250,000 ohm potentiometer
- One 3 ohm fixed resistor (or 10 for six volt source)
- One 6 ohm rheostat (or 20 for six volt source)
- One 20 ohm filament rheostat

#### Other Parts

- Four UX sockets
- Eight binding posts
- Two dials for condensers
- Two 232 screen grid tubes
- One 230 tube
- One 231 tube
- Three 7.5 volt grid batteries
- Three 45 volt plate batteries

# Utilization of House Current

By Brainard Foote

**I**F you utilize to best advantage for your radio set the possibilities of whatever kind of electric power you have in your home, you will save much expense and trouble in operating your equipment.

Whether you have 32 volt farm electric plant, 110 volt alternating current or 110 volt direct current, the power available can be turned to radio use quite easily.

In some instances, this simply means purchasing a good all-electric radio set. In other cases, where conditions are different, it may mean the attachment of A or B eliminators, power amplifiers, electrically-operated loudspeakers, etc. It may also mean using resistors of various types to reduce the voltage to a point suitable for radio power.

## The Types Used on Farms

There are two types of 32 volt farm plants in use. The simplest equipment comprises a gasoline or oil engine which drives an electric generator which furnishes the current for the house light and power. This system cannot be employed directly on the radio set because of the hum due to the commutator of the dynamo. However, the system can be easily used for charging the radio battery.

The more common form of farm plant uses a set of large storage batteries kept charged by the generator. The current for house lighting and power comes from the batteries and not from the generator. On this account, the current is absolutely steady and can be used to replace the regular storage battery. Radio manufacturers furnish special resistor devices at small expense for this purpose. One type has an adjustable resistance and a voltmeter so that you can regulate the voltage applied to the set to the correct value of 6 volts.

## Using Farm Batteries

It is also possible to make a direct connection to the batteries of the farm plant, so as to avoid necessity for a special resistor or other device. The difficulty is to have a uniform drain on the batteries. There are 16 cells in the plant, 2 volts each, a total of 32 volts. The radio battery, using only 6 volts, has three cells. Hence it is necessary to connect to only three of the plant cells at a time.

A good plan is to change once a week so as to use a different group and, as far as is possible, keep an even average use of the entire plant so as not to discharge any of the cells too heavily as compared with the others.

In making connections of this kind, a little radio experience may be needed, to avoid the danger of a short-circuit through the ground post of the set. Generally the simplest way to avoid this is to connect a fixed condenser of about 2 mfd. capacity between the ground post of the set and the ground, in place of a direct wire. Radio results are the same, but there is no direct connection for battery current.

Many listeners utilize an auto or engine battery for radio

use. A car that is operated in the daytime maintains the battery fully charged all the time, and there is always an excess of energy available. By means of a long enough pair of heavy wires to reach the garage, connection may be made to the car battery and plenty of energy is at hand to run the radio set every evening.

## 110 Volt DC and AC Systems

In some localities 110 volts direct current form the home supply. This is true in downtown city sections and in certain other areas, generally where there is a large private power plant nearby. Ordinary alternating current radio sets cannot be operated from a DC source. Several expedients are resorted to. One is to use the special miniature motor-generator sets now available. The motor is operated by the DC power, and is connected on the same shaft with a generator of 110 volts alternating current. This runs any standard radio.

Another plan is a special wiring of the set, or a special set, in which the tubes are connected in series and a resistor unit is used to reduce the 110 volts to the proper value to light the tubes. The 110 volts DC may also serve to furnish the B voltage up to about 100 volts, and additional B batteries are used to supplement the voltage to 135, 180 or whatever may be required by the tubes. This should not be overlooked, as marked battery economy is made possible.

The almost universal system for home lighting is 110 volts alternating current. Standard radio sets are built to operate from this source of power. The owner of a battery type set should take steps to utilize the 110 volt AC as fully as possible, because great saving in running expenses are available. The B eliminator probably represents the biggest improvement in economy, doing away with B battery costs forever. I suggest the tube type of eliminator, as the rectifier tube may be replaced with a new one every year or so, as needed, with less trouble than with older types of eliminator using dry or wet cells.

Trickle chargers will keep the storage battery in condition, or better still, an A eliminator may be used. This is, in principle, a rectifier unit the same as used in a trickle charger, and a filter system added, with voltage adjustment and voltmeter. These devices operate the set the same as do batteries, and offer savings in dollars and in trouble.

## May Use Combination

A worthwhile forward step for an older model radio set is to purchase a combination power amplifier and B eliminator. This replaces the regular power tube of the set and gives you plenty of volume with good tone quality maintained. In addition, it furnishes the B voltage for the rest of the outfit. The only problem remaining is that of the storage battery, which may be met as outlined above.

Are you utilizing your home power sources as you are able to do? If not, get busy! Realize on the economies and convenience they offer you for so little expense.

# A Portable with 2-Volt Tubes

(Continued from preceding page)

and .02 megohm makes the detector of the power type. Since there is a great deal of amplification in the audio level and comparatively little in the radio frequency level, greater sensitivity may be obtained without any distortion or blocking by making the grid leak larger in value. The leak may be as high as 2 megohms.

The regeneration is controlled by the screen voltage. A 250,000 ohm potentiometer is connected from the 45 volt lead to the positive side of the filament and the screen lead is connected to the slider. Thus the screen voltage may be varied between 2 and 47 volts. This is an adequate volume control and the rheostat need not be touched after it has once been set correctly. However, either may be used for controlling the volume. A 0.1 mfd. condenser is connected from the screen to ground to by-pass the radio frequency currents appearing in the screen circuit.

The detector is coupled to the first audio tube by means of resistances and a stopping condenser and the first audio tube is coupled to the power tube by means of a choke coil, a resistance and a stopping condenser. The stopping condensers are of 0.3 mfd. capacity. These taken in conjunction with the high grid leaks, of 5 and 1 megohm, insure good amplification on the low audio frequencies as well as the high.

The output coupling device is a 30 henry choke and a 2 mfd. condenser. It is assumed that the speaker to be used is of the magnetic type or the inductor dynamic type. A dynamic speaker is not suitable for a portable set on account of the

necessity of providing for a field.

Since the coupling is part resistance and part inductance the chance of motorboating is small, especially if reasonably good B batteries are used. Of course, there is always a chance of motorboating in a direct coupled circuit. If it should occur in this circuit the low end of the speaker might be connected to B minus instead of to B plus. Also, by-pass condensers of larger capacities could be used to advantage. They are not necessary, however, unless motorboating does occur.

Grid bias must be provided for all the tubes with the exception of the detector. The first screen grid tube requires 3 volts, the first audio tube 4.5 volts, and the power tube 22.5 volts. It is recommended that three 7.5 volt grid batteries be used for bias, the type that can be tapped at every cell. The three are connected in series, of course, to give the 22.5 volts required by the power tube.

Since the tuning condensers are of a different capacity from those ordinarily used for broadcast reception, the coils must also be different. Since they should be small for portability let us wind them on 1.75 inch diameters. Let the wire be No. 28 enameled. This will require 108 turns for each of the two tuned windings. The primary of the input transformer should have about 25 turns, the primary of the interstage transformer 60 turns, and the tickler 50 turns.

In view of the fact that the windings will be comparatively long it is best to use fine wire for the two untuned windings of the inter stage coil, or else to wind them on a form which fits snugly inside the 1.75 inch form holding the tuned winding.



# The Reasons for Fading

## Transmission of Carrier Is By Two Distinct Waves

AS a radio listener you have certainly experienced the phenomenon of "fading"—that queer and sudden change in the volume that you so often notice on distant stations. You find this effect at night more than in the daytime.

What is the cause of fading? This has been a subject of scientific debate for years, and the consensus of opinion nowadays explains fading as follows:

### Double Wave

Radio signals are transmitted by means of two distinct waves. One of these goes up into the air from the broadcasting station's aerial and the other wave travels along the surface of the earth. For nearby reception only the earth wave reaches the aerial directly from the broadcasting station and furnishes you with steady and strong reception.

At distances of 50 miles or over, conditions are very different. The air wave apparently goes up into space very far and is then reflected back to the earth.

The wave that travels along the earth goes directly to the receiving set. The air wave, however, travels a longer distance. Considering a single wave impulse, the wave which is reflected back to earth arrives at your receiving aerial a little later than the one which comes directly along the surface of the earth. The two waves are said to be "out of phase." The degree to which they are off phase affects the loudness, and if the reflection effect changes, very great changes in the loudness occur.

### Heaviside Layer

The reason for the reflection of the air wave back to the earth is best explained by the principle of the "Heaviside Layer," advanced by Sir Oliver Heaviside. This theory checks up most accurately with other facts that we know about the earth's atmosphere.

At 100 miles above the earth's surface or thereabouts, the air

is extremely thin or "rare." The ultra-violet light from the sun is able to penetrate into this air to a considerable depth. Its action is to "ionize" the molecules of the air into separate positive and negative ions. Ionized molecules make this air able to conduct electricity. This section of the earth's atmosphere is known as the "Heaviside Layer."

### Reflection Angle

The radio waves cannot pass through any conducting medium such as iron, steel, or this ionized layer of air. Accordingly, the waves are reflected back toward the earth. In the daytime the strong ultra-violet waves from the sun go deeper into the atmosphere and therefore the Heaviside Layer is closer to the earth. On this account the waves are reflected almost straight down again. Hence, we do not find much long distance reception of broadcasting in the daytime.

At night, however, the ultra-violet rays are very weak and the positive and negative parts of the air come together again. The Heaviside Layer is therefore much higher above the earth. This means that the waves are reflected at a less acute angle so that they are able to spread farther out and cover a larger section of the earth. Accordingly, you are able to receive much farther at night than in the daytime.

### Frequency

The angle of reflection appears to be undergoing constant changes. This effect is very pronounced on the shorter waves (higher frequencies).

So great is this Heaviside effect on waves such as 20 to 40 meters that the waves "skip" certain nearby sections altogether, being received strongly at distances of 500 or 1,000 or more miles way.

The above summarizes the present scientific opinion on the actions of radio waves and the explanation of "fading."

## Crystal Sets Still in Use

INTEREST in the crystal detector type of radio set has by no means died out, although we do not hear so much about them as we used to. The crystal set has definite possibilities in extreme economy, good tone quality and simplicity.

The crystal set seldom proves satisfactory in or near a city where there are 3 or 4 or more powerful broadcasting stations. This is because the simple circuits used in a crystal set are not selective enough to bring in one station alone. Where the location is about 30 miles or less from a strong broadcasting station, and where there are few, if any, other stations nearby, good results may be obtained.

The aerial should be of large size because we must intercept as much energy as possible in order to secure satisfactory volume.

The crystal detector itself may be of the adjustable type, which is the most sensitive, or the semi-adjustable carborundum type. If the carborundum style is used a dry battery should preferably be employed with it.

Although limited for use with earphones, the crystal set can prove entertaining, and it is unequalled as an instructive and inexpensive toy. The reproductive quality of the crystal set is good also.

## Coupling a Dynamic Speaker

THE dynamic type loud speaker is operated on a relatively heavy current and low voltage from the power tube. This is accomplished by means of a "step-down" transformer. It is important that the proportions of the primary coil of this coupling transformer should be properly matched to the power tube.

Most dynamic speakers of the better class are furnished already equipped with the proper kind of coupling transformer for the particular power tube or tubes with which they are to be used. When a dynamic speaker is connected to a set which

formerly had another kind of speaker, it is necessary to remove any coupling device in the set. This might be an output transformer or a condenser and a choke coil.

It is becoming a common practice to equip dynamic speakers with a multiple transformer which has an assortment of binding posts. In this way the proper connections will assure correct matching of the dynamic speaker with a single power tube, two power tubes connected in "parallel" or two power tubes connected in "push-pull." Coupling may be had with a condenser also.

## Tone Control Limitations

MANY advertisements and strong claims have appeared about the desirability of adding a "tone control" to a radio set.

There are certain advantages to be gained on some types of sets. If your radio set fails to amplify the low tones such as the drum and bass viol, no tone control can make it do so. On the other hand, if you find that the set sounds too shrill, so that the high notes are too loud in proportion, a tone control will enable you to get a better balance.

You will find that many of the best radio receiving sets are not equipped with this device. Such sets and the loud speakers designed to operate with them are properly made so that all of the low, medium and high tones are reproduced uniformly. Where the better grade of set is equipped with this device you will probably find that this is done more for advertising purposes than for real utility. On a less expensive make, the tone control is apt to prove of more value. The addition of a tone-control is occasionally improvement to the set.

A Question and Answer Department conducted by Radio World's Technical Staff. Only Questions sent in by University Club Members are answered. Those not answered in these columns are answered by mail.

# Radio University

Annual subscriptions are accepted at \$6 for 52 numbers, with the privilege of obtaining answers to radio questions for the period of the subscription, but not if any other premium is obtained with the subscription.

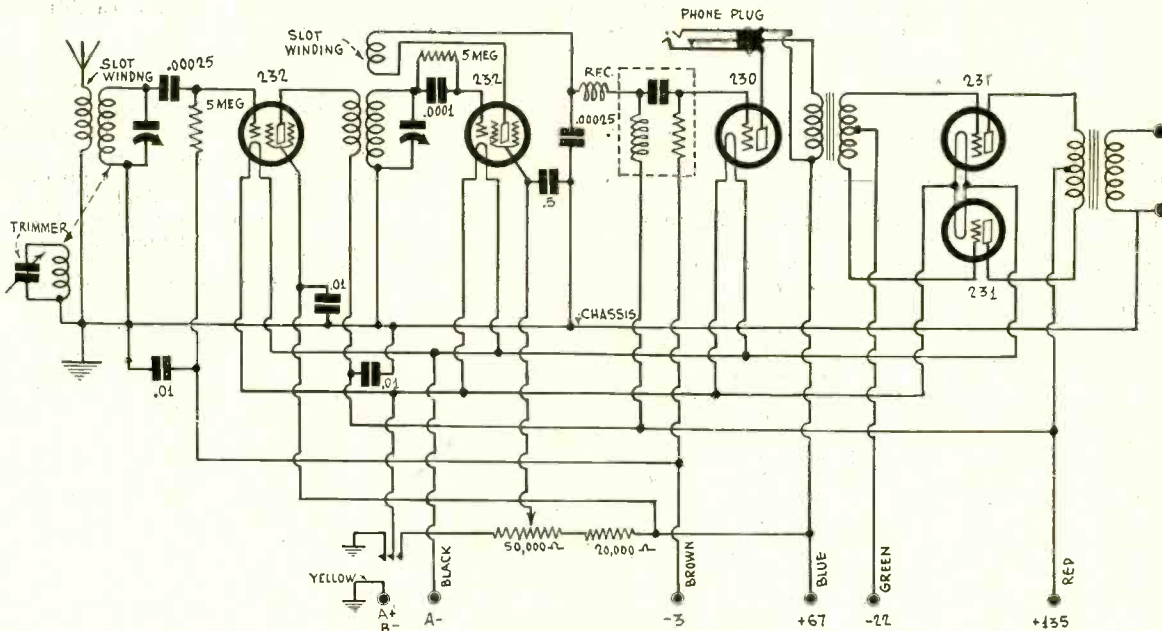

FIG. 888

A FIVE TUBE RECEIVER WHICH CAN BE USED ADVANTAGEOUSLY FOR A MIDGET BROADCAST. IT IS DESIGNED FOR USE WITH THE NEW 2 VOLT TUBES.

### Midget Receiver

WILL you kindly publish a circuit diagram of a receiver that is suitable to put in the midget form? I should like to have a stage of screen grid TRF, a screen grid detector, one stage of single audio and one of push-pull. If you can make it for the new two volt tubes I should appreciate it. Of course, if this is not practical it will be all right if you make changes.—T. C. R.

In Fig. 888 is the diagram of just the type of receiver you want. While this was originally intended for short-wave reception, it is equally suitable for a midget broadcast receiver. The only change needed is to make the tuning coils and the tuning condensers large enough for broadcast waves. The first tuned circuit marked trimmer may be omitted for broadcast reception. This leaves two tuning condensers, each of which should be .0005 mfd. The first coupling transformer should be a regular antenna coil wound for .0005 mfd. and the second should be a three circuit tuner also wound for the same capacity.

\* \* \*

### Stopping Motorboating

IF a 30 henry choke coil is substituted for one of the plate coupling resistors in a resistance coupled amplifier that motorboats, will the circuit become stable and will the quality remain good enough to justify this deviation from resistance coupling in the interest of stability? What changes are necessary besides the substitution of the choke coil?—W. J. F.

If the set motorboats and it cannot be stabilized by simple means, nothing is lost by substituting a choke coil since as long as the oscillation continues the amplifier is not good for anything. It really has no quality. If the substitution of the choke will stabilize it the circuit will at least give something worth listening to. But it is by no means certain the change will result in stability. It is worth trying, though, if other means have failed to stop the disturbance. When a choke is used for coupling the applied plate voltage required is usually less than when resistance is used, but if the applied voltage now is 180 volts or less, there is no need of changing it. Also, if the grid bias is obtained for the tube ahead of the coupler from a resistance in the cathode lead, a lower value resistance should be substituted. If the tube in question is a 227 the bias resistor should be 2,000 ohms.

\* \* \*

### Converter With Superheterodyne

I HAVE heard it said that a short-wave converter of the superheterodyne type cannot be used successfully with a broadcast superheterodyne. Is this correct, and if so, is there anything that can be done to make it successful?—T. C. C.

In general this statement is true because there is not enough RF amplification between the converter and the first detector in the superheterodyne. However, in many superheterodynes, especially in the more modern ones, there is a stage or two of radio frequency amplification ahead of the first detector and these work all right with converters. In case the superheterodyne does not have any radio frequency amplification a special converter in which a stage or two of intermediate is built in can be used. Take, for example, the converter published in the Jan. 31st issue of RADIO WORLD. It has one stage of intermediate built in and it can be used successfully with many superheterodyne receivers in which the RF amplification is not sufficient for other converters.

\* \* \*

### About the LC Ratio

IS it a fact that the higher the ratio of the inductance to the capacity in a tuned circuit, the higher the voltage developed across it for a given input voltage? That is, is the signal greater on the grid of a tube when the tuner ahead of it is composed of a large inductance and a small condenser than when it is composed of a small inductance and a large capacity?—B. F. L.

Other conditions being equal this is a fact, and this is one reason why a radio frequency amplifier is more sensitive at the upper part of the broadcast band than at the lower, that is, more sensitive at 1,500 than at 550 kc. The signal developed across the tuned circuit is proportional to the ratio of the inductance to the product of the inductance and the resistance in the circuit. The signal would be still greater were it not for the fact that the resistance increases with the frequency.

\* \* \*

### Turns Data for Small Broadcast Coil

HOW many turns of No. 28 enameled wire is needed on a 1.25 inch form to cover the broadcast band with a .0005 mfd. condenser? Is such a coil practical? Will the tuned winding be the same whether the coil is used with screen grid tubes or three-element tubes?—C. F. M.

Assuming that the distributed capacity in the circuit is 25 mmfd. you will need 67 turns. Since the distributed capacity may not be quite 25 mmfd. and since the tuning condenser capacity may not be quite .0005 mfd. it is best to put on at least 70 turns to start with and then remove one turn at a time until the condenser has to be set at about 98 to bring in 550 kc. Such a coil is quite practical and it is used in many tuned radio frequency sets. It is not recommended, though, unless there are several tuned circuits and several radio frequency amplifiers in the receiver. The tuned winding will be the same no matter what the tubes may be because the tuning range

depends on the inductance and capacity alone. When the maximum capacity and the lowest frequency in the tuning range have been determined the required inductance is also determined. The only influence the tubes have on the value of the inductance is the capacity between the grid and the cathode, which is put in parallel with the tuning condenser. This capacity is lumped in the 25 mmfd. assumed to be added in addition to the condenser capacity. The grid to cathode capacity is practically the same for all tubes.

**DC in Primary of Audio Transformer**

**F**REQUENTLY you show a filter in the plate circuit of a tube when the coupling is by means of transformer. That is, you feed the plate through a choke coil and then put the primary in series with a condenser which is connected to the plate of the tube. Just what is the advantage of this connection? I understand that one reason is that DC is to be kept out of the primary of the transformer in order to prevent saturation and distortion. But it seems to me that if an additional coil is used there would be still more distortion.—W. H. A.

This connection is only used when the DC plate current is high enough to cause considerable saturation if it were to flow through the primary. As a rule, it is only done when the highest grade audio transformers are used, those with high permeability core material. While it is true that the extra choke adds to the frequency distortion, the arrangement does improve the results by avoiding wave-form distortion due to saturation. The choke does not become saturated nearly to the extent that the core of the transformer would. Another advantage of the arrangement is that it permits returning the low side of the transformer to the cathode of the tube and thus to avoid feedback through the power supply. This alone in most cases justifies the connection and the extra parts. A little feedback can cause a great deal of distortion by greatly emphasizing some frequency. It may even cause oscillation.

**Reducing Modulation by Feedback**

**I**F an automatic volume control does not contain by-pass condensers would not the arrangement cause a reduction in the sensitivity of the receiver, and if the condensers are used and they are not large enough would not the arrangement reduce the modulation instead of the volume?—B. W. F.

If the automatic volume control circuit is not provided with any condensers, the result might be either a reduction in the sensitivity or an increase of it, depending on the phase of the feedback. And if the condensers used are not large enough there might be a reduction in the modulation. The condensers should be so large that the bias on the tubes changes only with slow changes in the radio frequency voltage. It should not change at an audio frequency rate or any higher rate. Still it must be responsive to changes due to rapid fading. If the fading rate falls in the audio range the automatic volume control is of little aid, but such fading is rare.

**Improving an Electric Clock**

**I**HAVE an old grandfather clock which is a real antique. It is a beautiful piece of furniture, but the mechanism is missing for the most part. I have also a synchronous motor designed for a phonograph pickup. This is such that it turns exactly 80 times a minute. Would it be possible by means of reduction gears to make this motor drive a clock mechanism? I wish to put the motor in the grandfather clock, of course. If this is feasible what kind of reduction gear is needed?—F. W.

This is quite feasible but perhaps it will cost more to run this clock than it should for the phonograph motor is more powerful than it need be. If the motor turns 80 times a minute and you use an 80 to one reduction gear, the speed would be right for the second hand, since this would turn around once a minute. A reduction gear of this ratio can be made by connecting a worm to the spindle of the motor and then engage this worm with a gear having 80 teeth. The gear would then turn around once a minute. If the clock mechanism does not have a second hand it would be necessary to reduce the speed again 60 to one. This, too, could be made with a worm and a matching gear, or it could be done with a gear and pinion. It is probable that you could equip the clock at less cost by buying an electric mechanism especially designed for clocks.

**Tuning the Choke in a B Supply**

**H**OW does a tuned choke in a B supply eliminate the hum? What should the inductance of the tuned choke be and what should be capacity of the condenser across it? Is it better that the choke coil have low or high resistance?—W. B. C.

The tuned circuit acts as a wave trap to the ripple, or as an impedance of very high value. It does not make so much difference what the values of inductance and capacity are just so that the two resonate at the principal hum frequency, that is, at 120 cycles in the case of a full wave rectifier on a 60 cycle line. In one commercial receiver the inductance is 24 henries and the capacity across it .073 mfd. The lower the resistance of the choke the more effective is the suppression of the hum, but the lower resistance the more critical is the tuning. If the resistance is very low it may be impossible to tune

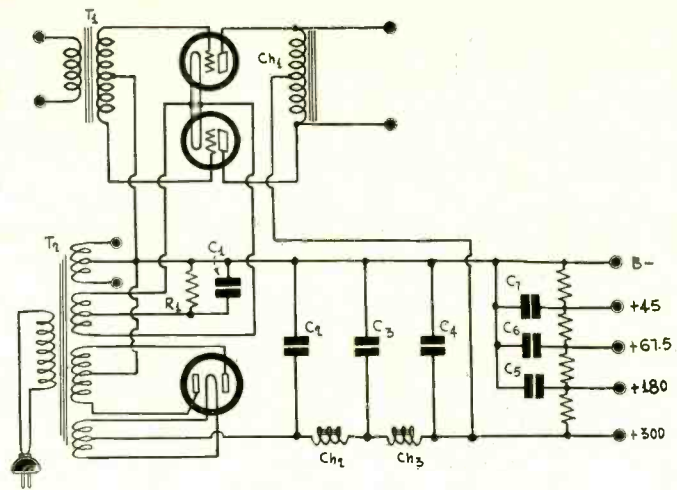

FIG. 889

THE DIAGRAM OF A PUSH-PULL AMPLIFIER USING 245 TUBES AND A POWER SUPPLY CIRCUIT CAPABLE OF HANDLING A MODERN TUNER AND FIRST STAGE AUDIO AMPLIFIER IN ADDITION TO THE PUSH-PULL STAGE.

the coil with a fixed condenser, or with a combination of fixed condensers due to the critical tuning or high selectivity of the circuit. Moreover, if the resistance is low, and hence the selectivity high, slight changes in the line frequency will detune the circuit and cause the hum to come through. This trouble is not serious now that electric clocks are used and the line frequency must be held, and is, to a high degree of constancy.

**Effect of Tone Control**

**I**S there any tone control that builds up the highs or the lows in case the amplification is deficient on either, or in case it is desired to have a greater preponderance of either? Or do all tone controls reduce the amplification on those frequencies which are not desired?—B. W. C.

While it would be possible to arrange a tone control that would build up those frequencies which are desired more strongly, such a device would be complex and would scarcely be practical. Those controls that have been put into sets are inevitably of the deemplifying type. They cut down the amplification on the lows or the highs according to whether the highs or the lows are desired in greater proportion. In order to bring up the volume it is necessary to manipulate the volume control whenever the tone control has been operated. Most tone controls not only reduce the amplification on those notes not desired but on all notes. This is one of the weaknesses of the tone control idea. The main weakness is that if a set has been designed and constructed to reproduce faithfully, all a tone control can do it to make the quality worse.

**Television Standardization**

**H**AS there been any standardization in the number of lines and the number of frames used in television, or is the subject still more or less hit or miss? If there has been any attempt at standardization what is it and is there any indication that there will be a change in the near future?—F. E.

Radio manufacturers interested in television got together and "standardized" on a speed of 900 revolutions per minute and 48 lines, the lines running from left to right and from top to bottom, in the order of reading a printed page. Since 900 a minute is equivalent to 15 a second, the number of frames per second in the "standardized" television picture is fifteen.

A 48 line, 15 frame picture is entirely unsatisfactory and for that reason it is not likely this "standard" will be adopted ultimately or even that it will be retained very long. Improvement in television must be sought in the increase of the number of lines per frame. The larger laboratories working on the problem are using 60 and more lines per frame, and it is quite possible that the number will be increased considerably even above that before satisfactory television will come. The problem is now to find room in the ether for channels required for images of a large number of lines per frame, and also to develop electrical circuits which will handle the wide channels.

**Push-Pull Amplifier and Power Supply**

**W**ILL you kindly show a diagram of a power supply and push-pull amplifier suitable for two 245 tubes and a 280 rectifier? This should also supply voltages for a radio frequency tuner utilizing 224 screen grid tubes.

Fig. 889 outlines such a circuit. If you use a Polo 245 power transformer and two 245 Polo chokes you will have a maximum rectified voltage of 300 volts, which is just right for 245 tube plate and grid voltages. By using a multi-tap voltage divider any desired voltage less than 300 volts may be obtained for the tubes in the radio frequency amplifier.

# DEMAND FOR DX IS ON INCREASE, SURVEY SHOWS

Washington.

Lawrence D. Batson, of the Radio Division of the Department of Commerce, finds that the appeal of DX listening has not suffered a relapse.

In a recent survey according to Mr. Batson, the demand for the type of receiver that reproduces the local program with exceptional fidelity has fallen off, and the sensitive type is taking its place.

The increasing prevalence of the high-powered station has resulted in the evolution of sets with a higher discriminatory ability and along with this the sensitivity level has been raised, the combination producing the long-range set.

## Local Situation Affects Performance

It is admitted that the extent of practical selectivity of the prevailing sets in a given community will depend on the distribution of the broadcast frequencies, and the power with which they are radiated. The most selective sets are found within the more crowded areas.

The nations of Europe and Australia are a good market for the selective set, due to the congestion that prevails in some quarters, and the same is true of Mexico, where the sets that are not selective enough are subject to interference, especially from distant stations of high power when reception is attempted in the hours after sundown.

## Increased Demand for DX

In the United States the demand for distance-reception is on the increase, due largely to the improved receivers, and if the means for supplying the type of program for reception at a distant point can be created, Mr. Batson feels that the popularity of the DX set will be greater than ever.

The particular application of the long-range radio set is to enable the programs of the radio centers to be heard in the out-of-the-way places where the concentration is very much below par, that is, the local stations operate only a few hours each day.

## Governor Installs Office Transmitter

Concord, N. H.

Governor John G. Winant, has caused a broadcasting unit to be installed in his office at the State Capitol. The installation is the first to be used in New England by any public official for executive addresses.

The Governor will use the station to lay the problems of importance before the people of the State. The present plans call for the presentation of bi-weekly addresses, which will be radiated by WBZ and WBZA.

Governor Winant said:

"During my administration I plan to use the radio and I heartily endorse it as an intimate and important means of public information."

## Dill Predicts 1-Meter Vision

Schenectady, N. Y.

Senator C. C. Dill, of the Interstate Commerce Committee, recently was invited to the Schenectady plant of the General Electric Co. by Dr. E. F. W. Alexanderson, to witness the progress of the commercialization of television transmission.

The Senator, author of two important radio Bills, and who in addition was instrumental in the permanent formation of the Federal Radio Commission, is of the opinion that progress has been great in television, which, however, is not yet commercially. The Senator sees no immediate necessity for new legislation to anticipate the special needs of the television art, as in his opinion the present scope of the radio law is ample to take care of the requirements, but intimated that necessary revisions would be made when the occasion warranted.

He predicted television images would whirl through space on waves of less than one meter.

## EXPERT LISTS PIRACY CASES

A recent copy of the Columbia Law Review carries an article by Louis G. Caldwell former General Counsel of the Federal Radio Commission, on "The Exploitation of Radio Programs," naming eight classes of radio pirates which commercially exploit programs that they do not originate.

The radio law now prohibits the retransmission of a program without express authorization, and consequently this form of piracy is practically non-existent, he said, but internal retransmissions by various hotels of programs from stations is being practiced to an increasing extent, he added. It is reported that phonograph records of broadcasts have been made for sale, although no specific case was mentioned.

The operation of loudspeakers for the benefit of the public at large is also a form of piracy that is rampant, he charged, but there is apparently nothing to be done about it at present. He said he knows of instances where there are certain taxicab concerns that use the name, Fresh Air Taxicab Co.

He pointed out that the operation in theatres of loudspeakers that reproduce broadcast programs is still another form of common piracy.

## Hoover's Son to Have An Amateur Station

Ashville, N. C.

Herbert Hoover, Jr., recuperating at Ashville, N. C., is to have an amateur broadcasting station, chiefly as a means for enabling him to while away the time.

The medical assistant, a Navy man, is helping out with the preliminary work, and it is expected that the station will be in working trim shortly.

# LANGMUIR TUBE DECISION UNDER JOINT ATTACK

Washington.

In a brief submitted to the Supreme Court of the United States, a number of influential and interested concerns set forth their views of the Langmuir tube patent situation. It is contended that the upholding of the validity of the Langmuir tube patent will result in a worldwide radio tube monopoly, and will permit the exaction of a toll from every family that uses a radio receiver.

The brief is in the name of the Chemical Foundation, Inc., the Radiological Society of North America, the Radiological Research Institute, Inc., and the Federal Telegraph Co.

## Vacuum Tubes Vital

The brief sets forth:

"It is concededly impossible to carry on modern radio communication without high vacuum tubes, and since the invention attributed to Langmuir by the Third Circuit Court of Appeals upon the rehearing is held to be this precise thing without limitation, the entire art will be at the mercy of Langmuir's assignee.

"Not only would all commercial radio telegraphic communication be delivered into the hands of the Radio Corporation and the entire X-ray tube art be delivered into the hands of the General Electric Company, but in addition to this, large numbers of persons not directly affected by these considerations would feel the result of the decision.

## Fear of Royalty Burden

"Except upon the payment of burdensome royalties, no manufacturer could build tubes especially suited to his product, and all communication systems, such as those used on airplanes, ships and elsewhere (including those of the Army and Navy, would be subject to their domination."

## Literature Wanted

Readers desiring radio literature from manufacturers and jobbers concerning standard parts and accessories, new products and new circuits, should send a request for publication of their name and address. Send request to Literature Editor, RADIO WORLD, 145 West 45th Street, New York, N. Y.

G. H. Washington, 209 No. 13th St., Omaha, Nebr.

Howard A. Johnson, 705 6th Ave., New Kensington, Pa.

Arthur Lego, 129 Portsmouth St., Jackson, Ohio.

Carl F. Griswold, Box 159, Syracuse, Kans.

Elmer C. Frey, 404 E. Howard St., Winona, Minn.

Robt. Bennett, Prop., Bronx Radio Sales Co., 2000 East 177th St., Bronx, N. Y. City.

J. C. Reed, McBaine, Mo.

Reed Barton, 1718 Ridge Ave., Coraopolis, Pa.

E. Brassard, 937 Francis Ave., Schenectady, N. Y.

J. M. Sweetman, 422 Banks St., New Orleans, La.

Wm. B. Searo, 14 Foxcroft Hall, Andover, Mass.

Raymond Sawchuk, 325 3rd, W. Easton, Pa.

Robert MacDonald, 517 E. Goepf St., Bethlehem, Pa.

Wm. L. Osborne, Jr., 22 Morris St., Springfield, Mass.

B. M. Robinson, Box 403, Lake Worth, Fla.

E. L. Boyle, 484 Hope St., Providence, R. I.

Robert Chandler, Arcade Box 1004, Los Angeles, Calif.

H. A. Adams, Rutland, Vt.

K. F. Wampfler, 21 Harmon St., White Plains, N. Y.

Leo Giess, Gies & Spang, P. O. Box 1473, San Antonio, Texas.

**SCREEN GRID SHIELDED COIL, \$1.50**

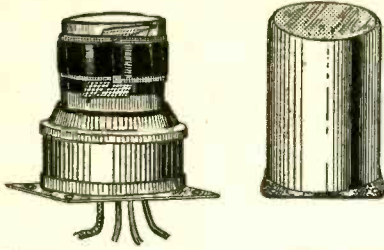

THESE shielded coils are especially suitable for screen grid circuits, but are adaptable also to other circuits.

They consist of a secondary wound on a 1 1/2" diameter bakelite tubing, a layer of moisture-proof insulating fabric, and primary wound over the secondary. The bakelite tubing is firmly embedded in veneered base, to which an aluminum plate is attached at bottom, punctured to pass outleads and to coincide with mounting holes of the aluminum shield. The shield size is 2 11/16" x 2 11/16" x 3/4". The mounting method keeps the walls of the shield equi-distant from the coil. The outleads are: shielded wire lead to plate, red lead to B plus, dark blue lead to grid and yellow to ground. When the coil is used as antenna coupler a fixed condenser of .00025 mfd should be in series with the aerial. The connections would be: shielded wire to fixed condenser, red and yellow both to ground and dark blue to grid. The coils are packed in matched sets of four. Thus they are of precision type, necessary for fully effectiveness from gang tuning.

The primaries are of high impedance and the coupling to the secondary is very tight. These features are desirable for high gain in multi-stage screen grid circuits. However, for circuits using other tubes, the primary turns may be easily reduced by the user to 10 turns, by cutting the primary wire near where it enters the insulating cloth, and unwinding all but 10 turns, cutting and then soldering the two wires together.

For .0005 mfd. tuning order Cat. 40-70.....@ \$1.50  
 Matched set of four for .0005 mfd. Cat. 40-70MF \$5.00  
 For .00035 mfd. tuning order Cat. 40-80.....@ \$1.50  
 Matched set of four for .00035 mfd. Cat. 40-80MF \$5.00

**DYNAMIC TUNER ASSEMBLY, \$1.25**

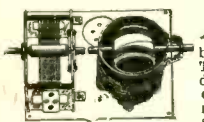

A TUNING condenser with a dynamic coil to match, mounted on an aluminum base that has socket built in. The condenser shaft goes in a dial (not furnished). The tuned circuit includes a fixed and a movable winding (rotor coil) in series. The moving coil is used as a trimmer, set once and left thus, so two separate tuning dials are made to read alike, or gang tuning is made practical. No equalizing condensers needed. Do not couple the adjoining shafts.

For antenna circuit input to any tube fitting four-prong UX socket, or for interstage coupling for 226, 201A, 199, 240 or 230, but NOT interstage for 232 or 222, order cat. BT-L-DC @ \$1.25  
 For interstage coupling for 232 and 222, order cat. BT-R-DC @ \$1.25  
 For antenna circuit, as RF input to any five-prong tube, order cat. BT-L-AC @ \$1.25  
 For interstage coupling for 224, order cat. BT-R-AC @ \$1.25

**DYNAMIC RF COIL, 75c**

THE dynamic coil for either .0005 mfd. or .00035 mfd. tuning. The same coil serves either capacity, as the series rotor may be set in position to increase or reduce the total secondary inductance.

For antenna coil, all circuits, and interstage coupling for all tubes except screen grid, order cat. BT-3A... @ 75c  
 For interstage coupling from plate circuit of screen grid tube order cat. BT-3B @ 75c

**DIAMOND PAIR COILS, \$1.20**

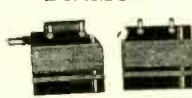

The Diamond of the Air is a popular circuit using an antenna coil and a three-circuit tuner. For this circuit the standard Diamond pair of coils consists of two, wound on 3" diameters, except for rotor on smaller form. The standard pair may be obtained for .0005 or .00035 mfd. tuning. Tickler coil has single hole panel mount.

For .0005 mfd. order SDP-5.....@ \$1.20  
 For .00035 mfd. order SDP-35.....@ \$1.20  
 These coils will give extreme satisfaction and are excellent for the Diamond of the Air, being specified by Herbert Bernard, the designer of the circuit.

**OTHER COILS**

- (Cat. 5-HT)—Special three-circuit tuner for .0005 mfd tuned primary in plate circuit of a screen grid tube; untuned secondary .....\$ .95
  - (Cat. 3-HT)—Same as Cat. 5-HT, except that it is for .00035 mfd. tuning .....\$ .95
  - (Cat. T-5)—Standard 3-circuit tuner for .0005 mfd. where primary is for any type of tube other than plate circuit of screen grid tube .....\$ .80
  - (Cat. T-3)—Same as T-5, except for .00035 mfd. condenser instead of for .0005 .....\$ .80
  - (Cat. 2-R5)—Radio frequency transformer for .0005 mfd. condenser where high impedance untuned primary is in plate circuit of a screen grid tube, and secondary is tuned by .0005 mfd. ....\$ .60
  - (Cat. 2-R3)—Same as 2-R5, except that it is for .00035 mfd. tuning .....\$ .60
  - (Cat. 5-TP)—Radio frequency transformer for use where primary is tuned and placed in plate circuit of screen grid tube, while secondary is not tuned. For .0005 mfd. ....\$ .55
  - (Cat. 3-TP)—Same as Cat. 5-TP, except that it is for .00035 mfd. tuning .....\$ .55
  - (Cat. RF-5)—Radio frequency transformer for .0005 mfd. tuning, where untuned primary is in plate circuit of any type tube except screen grid. Useful also as antenna coupler .....\$ .55
  - (Cat. RF-3)—Same as Cat. RF-5, except that it is for .00035 mfd. tuning .....\$ .55
- Remit with order for coils and we pay transportation. C.O.D. orders filled.

**SCREEN GRID COIL CO.**

143 WEST 45TH STREET  
 NEW YORK, N. Y.

**Orders-Inquiries**



60 pages Send for FREE COPY Can be Secured by MAIL

**POLK'S REFERENCE BOOK and Mailing List Catalog**  
 Gives counts and prices on over 8,000 different lines of business. No matter what your business, in this book you will find the number of your prospective customers listed.  
 Valuable information is also given as to how you can use the mails to secure orders and inquiries for your products or services.

Write for Your FREE Copy  
**R. L. POLK & CO., Detroit, Mich.**  
 Largest City Directory Publishers in the World  
 Mailing List Compilers—Business Statistics  
 Producers of Direct Mail Advertising

**DEALERS and SERVICE MEN!  
 STANDARDIZE ON**



For Permanent Replacement—Accurate—Guaranteed

Write for descriptive catalogue "W"

LYNCH MFG. CO., INC., 1775 Broadway, New York

**HAYDEN'S DANDY MIDGET!**

All parts, complete, as specified by Herbert E. Hayden, including cabinet (less tubes) ..... **\$22.46**

**Guaranty Radio Goods Co.**  
 143 West 45th Street  
 New York, N. Y.

**SHIELDED LEAD-IN WIRE**

No. 18 solid wire, surrounded by a solid rubber insulation covering, and above that a covering of braided copper mesh wire, which braid is to be grounded, to prevent stray pick-up.



This wire is exceptionally good for antenna lead-in, to avoid pick-up of man-made static, such as from electrical machines.

Also used to advantage in the wiring of receivers, as from antenna post of set to antenna coil, or for plate leads, or any leads, if long.  
 Order Cat. SH-LW. List 9c, net. 5c per ft.

143 West 45th St., New York, N. Y.  
**GUARANTY RADIO GOODS CO.**

**Ready NOW!**

**New Complete**

**ELECTRAD CATALOG**

36 pages of valuable data on Resistors, Voltage Controls and Loftin-White Amplifiers. Write Dept. RW-27 for your copy. Enclose 10c. (stamps or coin) for mailing cost.

175 Varick St., New York, N. Y.  
**ELECTRAD**  
 INC.

**RADIO MAP**

**OF NORTH AMERICA**

22 x 22 inches, printed in two colors, bound in cover.

Shows every city from Balboa to Edmonton which has a broadcasting station.

Indexed by states, provinces and cities with key for instant location on map.

Call letters, power and frequency given for each station.

**Accurate; up-to-date**

Scale in miles gives distances between any two cities. Time zones correctly marked.

Just what you have been wanting.

**25 cents**

**THE RADEX PRESS**

1368 E. 6th St. Cleveland, Ohio

**AMER-TRAN AUDIOS**



First stage, de luxe (illustrated), primary, in detector circuit, has 200 henrys inductance at 1 ms; turns ratio, 1-to-3. Cat. DL-1, list price, \$8.00 net \$4.70.

Push-pull input transformer, turns ratio, 1-to-3 1/2; single primary; two separate windings for secondary; Cat. 151, list price, \$12; net, \$7.05.

[Remit with order and we pay transportation.]

**GUARANTY RADIO GOODS CO.**  
 143 West 45th Street, New York, N. Y.

**FILL OUT AND MAIL NOW**

**SUBSCRIPTION BLANK**

**RADIO WORLD**

RADIO WORLD

145 West 45th Street, New York City

Please send me RADIO WORLD for .....

..... months, for which

**SUBSCRIPTION RATES:**

- Single Copy.....\$ .15
- Three Months.....1.50
- Six Months.....3.00
- One Year, 52 Issues.....6.00

please find enclosed

Add \$1.00 a Year for Foreign Postage; 50c for Canadian Postage.  
 If this is a renewal, put cross in square at left.

## Multi-Tap Voltage Divider

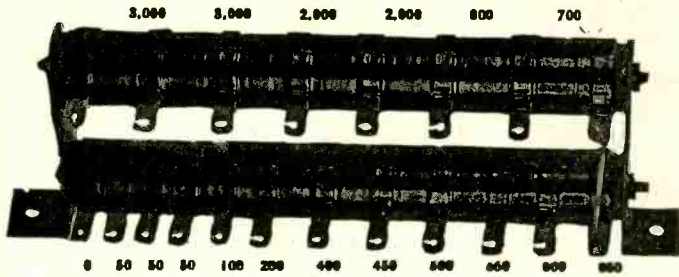

The resistance values between the twenty taps of the new Multi-Tap Voltage Divider are given above. The total is 17,100 ohms and affords nineteen different voltages.

The Multi-Tap Voltage Divider is useful in all circuits, including push-pull and single-sided ones, in which the current rating of 100 milliamperes is not seriously exceeded and the maximum voltage is not more than 400 volts. Higher voltages may be used at lesser drain. Conservative rating, 40 watts.

**GUARANTY RADIO GOODS CO.**

143 W. 45TH ST., NEW YORK, N. Y.

The expertness of design and construction will be appreciated by those whose knowledge teaches them to appreciate parts finely made.

When the Multi-Tap Voltage Divider is placed across the filtered output of a B supply which serves a receiver, the voltages are in proportion to the current flowing through the various resistances. By making connection of grid returns to ground, the lower voltages may be used for negative bias by connecting filament center or in 2T and 2T4 tubes, cathode to a higher voltage.

If push-pull is used, the current in the biasing section is almost doubled, so the midspan of the power tubes' filament winding would go to a lug about half way down on the lower bank.

Order Cat. **MTVD.**

list price **\$2.95**  
\$6.50  
net price..

## Short-Wave Converter Series

In the November 8th issue of RADIO WORLD there began a remarkable series of articles dealing with the construction of short-wave converters that really do work, and that work well. Besides, the cost of parts is low. One model, 30 to 110 meters, no plug-in coils, may be built of parts costing less than \$5, for battery operation, or for AC with extra filament transformer external, while another model, 10-200 meters, two plug-in coils, using somewhat superior parts, filament transformer built-in, can be made up by you for less than \$10. Surely these are prices within the reach of all.

Low price and high achievement go hand in hand in these designs by Herman Bernard.

The series ran in the November 8th, 15th, 22nd and 29th, and December 6th, 13th, and 20th issues. Send \$1 and we will forward these seven issues and a blueprint of the AC \$5 model.

RADIO WORLD, 145 West 45th Street, New York, N. Y.

Enclosed please find \$1.00 for which send me the November 8th, 15th, 22nd and 29th, and Dec. 6th, 13th and 20th issues, containing the series of articles on short-wave converters of extremely low price, and a blueprint of the AC \$5 model.

Name .....

Address .....

City ..... State .....

### VERSATILE SPEAKER UNIT—FOR HOME OR PORTABLE

FIDELITY HORN UNIT. Stands up to 450 volts without filtering. Order Cat. FDU, with 50-inch tipped cord, weight 2½ lbs.; size 2¾-inch diameter, 2¾-inch height. Price, **\$1.95**. Guaranty Radio Goods Co., 143 West 45th St., N. Y. C.

## Save Money on Tubes!

**Get a Guarantee Just the Same!**

**QUALITY** tubes at enormously reduced prices enable you to save money and obtain full satisfaction. Any tube will be replaced on request within thirty days of its sale!

These tubes are made by a manufacturer of national reputation and are not "distress merchandise." No tube is shipped until it is carefully checked on a Readrite No. 9 Radio Test Kit.

Type	List Price	Your Cost	Type	List Price	Your Cost	Type	List Price	Your Cost
<input type="checkbox"/> 201A	\$1.25	49c	<input type="checkbox"/> WD-12	\$3.00	59c	<input type="checkbox"/> 245	\$2.00	59c
<input type="checkbox"/> 226	1.75	49c	<input type="checkbox"/> 200A	4.00	59c	<input type="checkbox"/> 280	1.90	59c
<input type="checkbox"/> 199-UX	2.50	59c	<input type="checkbox"/> 171A	2.25	59c	<input type="checkbox"/> 224	3.30	59c
<input type="checkbox"/> 199-UV	2.75	59c	<input type="checkbox"/> 171AC	2.25	59c	<input type="checkbox"/> 222	4.50	95c
<input type="checkbox"/> 120	3.00	59c	<input type="checkbox"/> 112A	2.25	59c	<input type="checkbox"/> 281	7.25	95c
<input type="checkbox"/> WD-11	3.00	59c	<input type="checkbox"/> 227	2.20	59c	<input type="checkbox"/> 210	9.00	95c

250, List \$11.00, your cost, 95c.

[Remit with order for tubes and we pay postage]

**DIRECT RADIO CO.**

143 West 45th St., New York, N. Y.

### ERLA DYNAMIC CHASSIS, WESTINGHOUSE RECTIFIER—

List price \$25.00; our price \$10.50. Guaranty Radio Goods Co., 143 W. 45th St., N. Y. C.

### Subscribers: watch the date line on your wrapper

If the expiration date line on your wrapper indicates that your subscription has expired or is about to expire, please send in renewal so that you will not miss any copies of the paper. Subscription Dept., Radio World, 145 W. 45th St., N. Y.

# Quick Action Classified Ads

Radio World's Speedy Medium for Enterprise and Sales

7 cents a word—\$1.00 minimum—Cash with Order

**FILAMENT TRANSFORMERS**—1½, 2½, 5 volt, \$1.00; 2½ volt, 5½ amp., \$1.10; 7½ volt, 3 amp., \$1.25. C. T. secondaries, primary 110 volt. Write L. Waterman, 2140 Kirby West, Detroit, Mich.

**RESISTANCES, CONDENSERS, TRANSFORMERS, CHOKE-COILS,** etc. Write for sensational low price list. Bronx Wholesale Radio Company, 7 West Tremont Avenue, New York.

**"THE PEANUT VENDOR"**—Cuban novelty song, 35c, postpaid. "There's Something Missing in Your Eyes"—latest radio fox-trot song hit, 35c, postpaid. The Columbia Print, 145 W. 45th St., New York.

**"A B C OF TELEVISION"** by Yates—A comprehensive book on the subject that is attracting attention of radioists and scientists all over the world. \$3.00, postpaid. Radio World, 145 West 45th St., N. Y. City.

**BARGAINS** in first-class, highest grade merchandise. B-B-L phonograph pick-up, theatre type, suitable for home with vol. control, \$6.57; phono-link pick-up with vol. control and adapter, \$3.32; steel cabinet for HB Compact, \$3.00; four-gang .00035 mfd. with trimmers built in, \$1.95; .00025 mfd. Dubilier grid condenser with clips 18c. P. Cohen, Room 1214, at 143 West 45th Street, N. Y. City.

**MAJESTIC, RADIOLA,** etc. Drum Dial Cable by foot or mile. Service men's test prods, 50c, 75c, \$1.00. Blan, the Radio Man, Inc., 89 Cortlandt St., New York.

**HORN UNIT,** \$1.95—This is the Fidelity Unit and has stood the test of time. Guaranty Radio Goods Co., 143 W. 45th St., New York.

**"MATHEMATICS OF RADIO,"**—A great help to everybody interested in radio. \$2 postpaid. Radio World, 145 W. 45th St., N. Y. City.

**FOR SALE HIQ 30 CHEAP.** F. L. Hanson, Iliion, N. Y.

**GOOD VOLUME,** 4 tube, loop Auto Radio blue print 50c. Parts cost \$12 complete. Write me. C. C. Burge (Radio Engineer), 301 E. Park Blvd., Villa Park, Ill.

**H.F.L. MASTERTONE.** List \$195. Sell \$85. World's finest radio. W. J. Reed, Aurora, Ill.

**PRINTING: 1000 BUSINESS CARDS \$2.75 POSTPAID.** Other printing reasonable. Samples free. Miller, (RW), Printer, Narberth, Pa.

**RADIO COURSES,** sets, books, bargains. Stephen Plavetich, 1597 East 47th St., Cleveland, Ohio.

**SALESMEN WANTED. 87 MILES ON 1 GALLON OF GAS?**—Startling Vapor Gas Saver. All Autos, Motorcycles. 1 Free. Critchlow, 3360-A, Wheaton, Ill.

# SHORT-WAVE SPECIALTIES

## EXTRA-SPECIAL FREE OFFERS OF SUBSCRIPTION PREMIUMS!

RADIO WORLD, now in its ninth year, is the first and only national radio weekly, and publishes the latest, up-to-the-second news of circuits, both of kit types and of 1931 commercial receivers, as well as news of happenings in the broadcasting field. Lists of broadcast and short-wave stations are published regularly. You get your information weekly—which means quickly—and you get it accurately, so be sure to become or remain a subscriber for RADIO WORLD. We are able to offer now specially attractive premiums, and ask you to make your choice from the well-chosen variety of parts offered on this page and on the opposite page. When ordering, please use coupon.

The regular subscription rates are: \$6 for one year, 52 issues, one each week; \$3 for 6 months, (26 weeks); \$1.50 for three months, (13 weeks); \$1 for 8 weeks; 15c per single copy.

### TUBE-BASE TYPE COILS

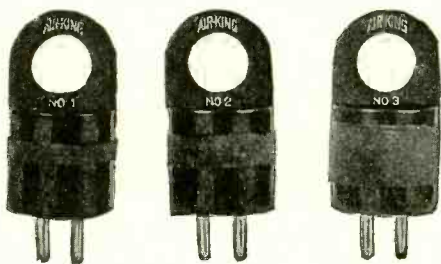

Three finger-handle type plug-in coils, wound on tube-base diameter, although of greater height than a tube base, for short wave plug-in service, where a 4-prong (UX) tube socket is used as coil receptacle. There are two separate windings, tightly coupled. The coil socket connections are: plate prong to plate, filament plus to phones; grid prong to grid and ant.; filament minus to stator of a feedback condenser. The tuning condenser (stator to grid prong, rotor to filament plus prong) may be .00015 or more for 15 to 110 meters; the feedback condenser .00025 mfd. B voltage is supplied through phones or audio transformer primary. Order PR-TBC free (less coil socket) with 6 mos. (26 weeks) subscription @ \$3.00

### PRECISION PLUG-IN COILS

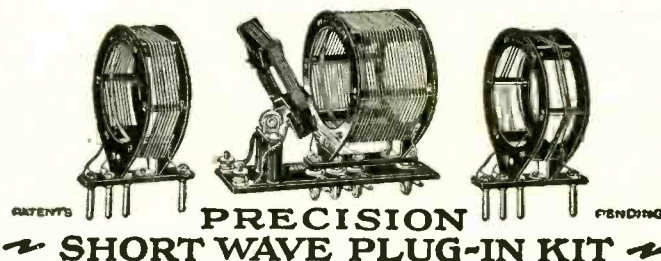

The finest short-wave coils, of de luxe construction, wound on ribs, affording 97% air dielectric, and available for various capacities of condensers, as listed below. All precision short-wave coils are provided with receptacle bases and apply to standard circuits.

For .0001 or .00015 mfd. tuning; three plug-in coils with receptacle base as illustrated, with adjustable primary built onto receptacle, 15 to 150 meters. Order PR-AK-1, free with one year's subscription @ \$6.00.

For .00025 or .0002 mfd. tuning; only two coils are required, for 15 to 150 meters. Order PR-AK-2, and get two coils, receptacle and adjustable coil (third inductance) built in. Free with nine months' subscription (39 weeks), at regular rate, \$4.50.

Note—We can supply .00015 mfd. (PR-H-15) or .0002 mfd. (PR-H-20) Hammarfund short-wave midline condenser, swings inside 2-inch diameter, with three months (13 weeks) additional subscription @ regular \$3 rate.

### "DIAMOND" PAIR IN STANDARD AND DE LUXE TYPES

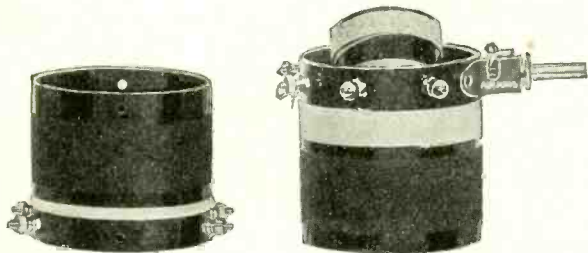

The Diamond of the Air is a popular circuit using an antenna coil and a three-circuit tuner. For this circuit the standard Diamond pair of coils consists of two, wound on 3" diameters, except for rotor on smaller form. The standard pair may be obtained for .0005 or .00035 mfd. tuning. Ticker coil has single hole panel mount. For .0005 mfd. order PR-SDP-5, with blueprint, free with a six-month subscription (26 weeks) @ \$3.00. For .00035 mfd. order PR-SDP-35, free with 6-month subscription @ \$3.00.

These coils will give extreme satisfaction and are excellent for the Diamond of the Air, being specified by Herman Bernard, the designer of the circuit.



De luxe Diamond pair, with large primaries center-tapped. For the Diamond use center tap and one extreme of the primary for antenna circuit. RF coil (at right); use full primary on ticker (lowest winding at left). The de luxe pair have silver-plated wire, for loss-reduction, wound on moulded bakelite, with threading, so coils are space-wound to reduce distributed capacity. Three-circuit coil is single-hole panel mount. Additional holes for optional base mounting on both, using brackets (not supplied.) For .0005 mfd. only. (None for .00035 mfd.) Order PR-GWN free with a year's subscription (52 issues) @ \$6.00.

### GET THE COMPLETE DATA ON SHORT-WAVE CONVERTERS

Short-wave converters are all the rage. They enable you to tune in short waves on a broadcast receiver of any kind. A serial article by Herman Bernard, on this topic, discussing several models, with full-size picture diagrams, was published in the November 8th, 15th, 22nd, 29th, December 6th, 13th and 20th issues. Send \$2 for 17 weeks' subscription and get these seven issues free. Order PR-SWCS.

### PARTS FOR A SHORT-WAVE CONVERTER

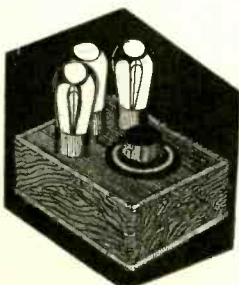

No matter what type of broadcast receiver you have, you can get short waves by using a short-wave converter built of parts we can supply. The panel is only 5 x 6 1/2 inches. There is only one tuning control. No squeals, howls or body capacity. Two models are available, one for A.C., the other for battery operation. The battery model uses three 227 tubes with heaters in series. Full details supplied with order.

All parts for A.C. model (less filament transformer, less three 227 tubes), order PR-SUP-3A, free with a year's subscription @ \$6.

All parts for the battery model (less three 227 tubes), free with a year's subscription for Radio World @ \$6.00. Order PR-SUP-3B.

A third model (of different appearance than illustrated) enables filament transformer to be built in. All parts, including filament transformer; two wound plug-in coils, 15-200 meters. Hammarfund condenser, (less tubes), order PR-SUP-3FS free with two-year subscription @ \$12.

### PLEASE USE THIS COUPON!

RADIO WORLD,  
145 West 45th Street, New York, N. Y.

I hereby take advantage of your extra-special premium offers and subscribe for RADIO WORLD for the number of weeks specified in the list below. Please send indicated premium. My remittance of \$ ..... is enclosed. RW-1-10

- PR-TBC (26 wks.) \$3.00
- PR-SDP-35 (26 wks.) \$3.00
- PR-AK-1 (52 wks.) 6.00
- PR-GWN (52 wks.) 6.00
- PR-AK-2 (39 wks.) 4.50
- PR-SWCS (17 wks.) 2.00
- PR-H-15 (13 wks.) 1.50
- PR-SUP-3A (52 wks.) 6.00
- PR-H-20 (13 wks.) 1.50
- PR-SUP-3B (52 wks.) 6.00
- PR-SDP-5 (26 wks.) 3.00
- PR-SUP-3FS (104 wks.) 12.00

Name .....

Address .....

City ..... State .....

Please put cross here if renewing an existing subscription.

# A Complete Line of Radio Books!

SERVICE MANUAL

RAMSAY

HAAN

RADIO MANUAL

ANDERSON and BERNARD

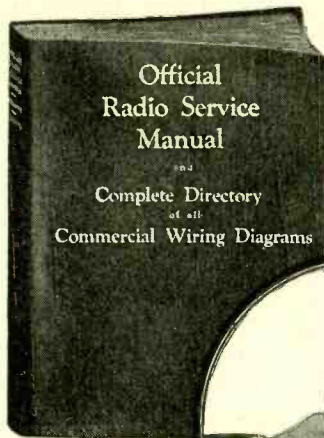

"Official Service Manual," by Gernsback and Fitch, 1,000 illustrations; diagrams of commercial receivers and power amplifiers; 352 pages; includes course on servicing. Weight, 3 1/2 lbs. Complete 6-page index. Flexible leatherette cover, loose-leaf binding. Order Cat. ORSM @ \$3.50



The index to the commercial wiring diagrams takes up five pages alone. The index is an alphabetical array of the manufacturers' names, with model names and numbers stated.

"Radio Trouble Shooting," by E. R. Haan, passes over theory, tells what to do to cure troubles. 301 illustrations, flexible binding 361 pages 6x9". Order Cat. HAAN... @ \$3.00

"Experimental Radio" by E. R. Ramsay, Ph.D., Prof. Physics, Indiana University. 255 pages, 168 illustrations. Cloth cover. Order Cat. REX... @ \$2.75

"Fundamentals of Radio," by Ramsay. 374 pages, 402 illustrations. Order Cat. RFM @ \$3.50

The new edition of "The Radio Manual" answers questions about the principles, methods, or apparatus of radio transmitting and receiving. A complete course in radio operation in a single volume. 20 big chapters include: Elementary Electricity and Magnetism; Motors and Generators; Storage Batteries and Charging Circuits; The Vacuum Tube; Circuits Employed in Vacuum Tube Transmitters; Modulating Systems and 100% Modulation; Wave-meters; Piezo-Electric Oscillators; Wave Traps. Nearly 900 pages, 369 illustrations; flexible fabricoid cover. Order Cat. MAN @ \$6.00



An understanding of audio amplifiers of all types, and of the use of tubes in audio channels, is a prerequisite today, when audio amplification is to be used in the fore in radio, in public address systems and in the tactics.

A "Audio Power Amplifiers" is the first and only book on the important subject. The authors are J. E. Anderson, M.A., former instructor in physics, University of Wisconsin, former Western Electric engineer, and for the last three years technical editor of "Radio World"; Herman Bernard, I.L.B., managing editor of "Radio World." The book begins with an elementary exposition of the historical development and circuit constitution of audio amplifiers and sources of power. From this simple start it quickly proceeds to a well-considered exposition of circuit laws, including Ohm's laws and Kirchhoff's laws. The determination of resistance values to produce required voltages is carefully expounded. All types of power amplifiers are used as examples: AC, DC, battery operated, and sparkless. But the book treats of AC power amplifiers most generously, due to the superior importance of such power amplifiers commercially. Tube characteristic tables and curves profusely included. Cloth cover, 193 pages. Order Cat. APAM... @ \$3.50

## BOOKS BY JOHN F. RIDER



Two new books by Rider are: (1) "Practical Radio Repairing Hints," a handbook for the radio worker. Replete with facts and figures, hints and kinks. No Theory. No Formulas. In it you will find explanations of the modern radio systems, automatic volume control circuits, new forms of voltage distribution in automobile radio sets, public address systems, etc. Order Cat. PRRH... @ \$2.00

(2) "Practical Testing Systems," the first complete collection of accurate and practical testing circuits of interest to the service man, professional as builder and experimenter. Among the many testing systems described in this book are tube testers, capacity measuring systems, signal generators, radio frequency oscillators, audio oscillators, vacuum tube voltmeters, resistance testers, continuity testers, etc. Material for the man who wants a simple test unit or desires a laboratory arrangement. Order Cat. PTS... @ \$1.00

Other books by Rider are: "Trouble Shooter's Manual," the first comprehensive volume devoted exclusively to the topic. It is not only a treatise for service men, telling them how to overcome their most serious problems, and diagramming the solutions, but it is a course in how to become a service man. It gives details of servicing and includes more than 100 actual factory-drawn diagrams of commercial receivers. 240 pages, 8 1/2 x 11", 200 illustrations. Order Cat. TSM... @ \$3.50

"Supplement No. 1," containing 115 diagrams of commercial receivers, supplementing the diagrams in "Trouble Shooter's Manual," but not duplicating any. These 115 diagrams are supplied loose. They are a necessary adjunct to those in "Trouble Shooter's Manual." Order Cat. SUPP-1... @ \$1.20

"Mathematics of Radio," by Rider, 128 pages, 8 1/2 x 11", 110 illustrations, bridges the gap between the novice and the college professor. It gives a theoretical background so necessary for a proper understanding of radio and audio circuits and their servicing. Formulas for capacity, inductance, impedance, resistance, etc., are explained. Flexible cover. Order Cat. MOR... @ \$2.00

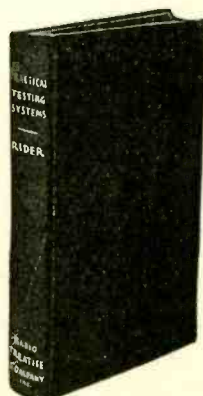

## The SUPERHETERODYNE

This is a new volume by Anderson and Bernard dealing with the principles and practice of the Superheterodyne method of receiving. It explains the function of the oscillator, the modulator, the pre-modulator selector, and the intermediate frequency amplifier. It explains the cause of repeat points and gives methods for avoiding them or minimizing their effect. It expounds the relative advantages and disadvantages of high and low intermediate frequencies, and shows the effect of selectivity on the quality.

It illustrates various forms of oscillators and tells of the advantages of each. Different types of modulators and pick-up systems are explained and their advantages stated. Different methods of coupling in the intermediate frequency amplifier are shown.

Image interference is discussed in detail and methods given by which it may be reduced. A special method of coupling the oscillator to the radio frequency condenser is explained, a method which allows either the high or the low oscillator setting to be selected by means of a variometer in the oscillator circuit.

One section is given over to coil design for the radio frequency tuners, the oscillator, and the intermediate frequency filter.

Audio amplifiers suitable for Superheterodynes are also described. These include transformer, resistance, and push-pull amplifiers both for AC and DC.

While the book is primarily intended to expound the principles of the Superheterodyne, the practical phase has not been neglected. Detailed descriptions of AC and DC Superheterodynes, designed in conformity with best practice and sound applications of the principles, have been included in the book. These descriptions are well illustrated. Order Cat. ABSH... @ \$1.50

## FOOTHOLD ON RADIO

In simple English that any one can understand, the technical side of radio is presented by Anderson and Bernard in their book, "Foothold on Radio." Any one who can read English can understand this book. It is intended for the sheer novice. The treatment is non-mathematical. The origin of the broadcast wave, its radiation, reception, amplification are set forth in clear language. Side bands are explained simply. The types of receiving circuits are illustrated, described and contrasted. A chapter is devoted to loudspeakers, explaining the different kinds and the principles of their operation. Performance is compared. Audio coupling is fully explained, also the action of the vacuum tube with a special analysis of plate current and its behavior. Those who have been thirsting for a book that readily reveals the marvels of the radio science will appreciate this little volume. Paper cover 60 pages, fully illustrated. Order Cat. For... @ \$1.00

## TWO MASTERPIECES BY PROF. MORECROFT

"Principles of Radio Communication," by Prof. John H. Morecroft, second edition. Prof. Morecroft, of the Electrical Engineering Department of Columbia University and past president of the Institute of Radio Engineers, is a noted authority. Prior electrical and mathematical knowledge required. 1,001 pages and 831 illustrations. Cloth-bound. Order Cat. M-PRIN... @ \$7.50

"Elements of Radio Communication," written in plain language, requiring little foundation knowledge of radio, is another fine Morecroft book. The book is a complete course on the elements of radio, containing much material never before published. 226 pages, 170 illustrations and a complete index. Cloth bound. This is one book you must have in your library. Order Cat. M-ELEM... @ \$3.00

## THREE BOOKS BY MOYER AND WOSTREL

The need for an up-to-date book on radio tubes that answers all the important questions has been filed by James A. Moyer, Director of University Extension, and John F. Wostrel, instructor in radio engineering. Division of University Extension, Massachusetts Department of Education. This book is a complete discussion of tube principles, functions and uses. The essential principles underlying the operation of vacuum tubes are explained in a non-technical manner as is consistent with accuracy. The book covers the construction, action, reactivation testing and use of vacuum tubes as well as specifications for vacuum tubes and applications for distant control of industrial processes and precision measurements. 297 pages, cloth bound. Order Cat. MWT... @ \$2.50

"Practical Radio," including the testing of radio receiving sets. 378 pages, 223 illustrations. Cloth bound. Order Cat. MWP... @ \$2.50

"Practical Radio Construction and Repairing," 319 pages, a companion volume to the above. New edition. New price. Order Cat. MWC... @ \$2.50

Radio World, 145 West 45th Street, New York, N. Y.  
 Enclosed please find \$..... for which please send at once, postpaid, books indicated by my crosses

<input type="checkbox"/> Cat. ORSM @ \$3.50	<input type="checkbox"/> Cat. PRRH @ \$2.00
<input type="checkbox"/> Cat. MAAN @ 3.00	<input type="checkbox"/> Cat. PTS @ 1.00
<input type="checkbox"/> Cat. REX @ 2.75	<input type="checkbox"/> Cat. TSM @ 3.50
<input type="checkbox"/> Cat. RFM @ 3.50	<input type="checkbox"/> Cat. SUP-1 @ 1.20
<input type="checkbox"/> Cat. MAN @ 6.00	<input type="checkbox"/> Cat. MOR @ 2.00
<input type="checkbox"/> Cat. APAM @ 3.50	<input type="checkbox"/> Cat. M-PRIN @ 7.50
<input type="checkbox"/> Cat. FOW @ 1.90	<input type="checkbox"/> Cat. M-ELEM @ 3.00
<input type="checkbox"/> Cat. ABSH @ 1.50	<input type="checkbox"/> Cat. MOR @ 2.50
<input type="checkbox"/> Cat. YEL @ 3.00	<input type="checkbox"/> Cat. MWP @ 2.50
<input type="checkbox"/> Cat. DRB @ 6.00	<input type="checkbox"/> Cat. MWC @ 2.50
<input type="checkbox"/> Cat. PRK @ 3.50	<input type="checkbox"/> Cat. RTT @ 7.50

Name.....  
 Address.....  
 City..... State.....  
 Check here if C. O. D. is desired.

## "A B C OF TELEVISION"

"A B C of Television, or, Seeing by Radio," by Raymond Francis Yates, editor of "Television," formerly editor of "Popular Radio," 210 pages (5 1/2 x 8 1/2"), 109 illustrations. Cloth bound. This book is not a dull, technical treatise. Rather, it is a popular, easily understood and practical book containing descriptions of television systems and also detailed information concerning many fascinating television experiments that may easily be conducted with modest equipment. It is not a book for engineering "high-brows" nor is it a superficial treatise written merely to entertain and amaze the novice. It is an intensely practical volume written for those who want to do things. It stresses the "how" of the art as well as the "why." In its essence, it is an academic treatise brought down to the level of the lay mind. Engaging in its simplicity, penetrating and wide in its scope, it stands as the first popular American book devoted to television and its telephotography. The book contains two hundred fifty pages profusely illustrated. The reading matter is arranged in simple stepping stones dealing with the problems of scanning, amplification of light modulated signals, photo-electric cells and neon lamps. The book has been written especially for those who wish to build and use television receivers and transmitters for entertainment and research purposes. It is written for amateurs and experimenters who crave action and results rather than high-sounding theory. Order Cat. TEL... @ \$3.00

"Drake's Encyclopedia," new edition, 2 1/2" thick, weighs 3 1/2 lbs., 920 pages, 1,025 illustrations. Order Cat. DRB... @ \$6.00

"Principles of Radio," by Keith Henney, M.A., former director, laboratory, Radio Broadcast. 477 pages, 303 illustrations. Order Cat. PRK... @ \$3.50

"Radio Telegraphy and Telephony," by Rudolph L. Duncan and Charles E. Drew, of Radio Institute of America. Order Cat. RTT... @ \$7.50

### Remit with Order for Books and We Pay Postage